



® ADEMCO

Security System

VISTA-10SE

THIS ISSUE INCLUDES THE NEW "QED" (QUICK ENROLLMENT OF DEVICES) PROCEDURE FOR 5800 SERIES TRANSMITTERS

Installation Instructions • Installation Instructions • Installation Instructions

N7227V5 5/97

RECOMMENDATIONS FOR PROPER PROTECTION

The following recommendations for the location of fire and burglary detection devices help provide proper coverage for the protected premises.

Recommendations For Smoke And Heat Detectors

With regard to the number and placement of smoke/heat detectors, we subscribe to the recommendations contained in the National Fire Protection Association's (NFPA) Standard #72 noted below.

Early warning fire detection is best achieved by the installation of fire detection equipment in all rooms and areas of the household as follows: For minimum protection a smoke detector should be installed outside of each separate sleeping area, and on each additional floor of a multi-floor family living unit, including basements. The installation of **smoke detectors** in kitchens, attics (finished or unfinished), or in garages is not normally recommended.

For maximum protection the NFPA recommends that you install **heat** or **smoke detectors** in the living room, dining room, bedroom(s), kitchen, hallway(s), attic, furnace room, utility and storage rooms, basements and attached garages.

In addition, we recommend the following:

- Install a smoke detector inside every bedroom where a smoker sleeps.
- Install a smoke detector inside every bedroom where someone sleeps with the door partly or completely closed. Smoke could be blocked by the closed door. Also, an alarm in the hallway outside may not wake up the sleeper if the door is closed.
- Install a smoke detector inside bedrooms where electrical appliances (such as portable heaters, air conditioners or humidifiers) are used.
- Install a smoke detector at both ends of a hallway if the hallway is more than 40 feet (12 meters) long.
- Install smoke detectors in any room where an alarm control is located, or in any room where alarm control connections to an AC source or phone lines are made. If detectors are not so located, a fire within the room could prevent the control from reporting a fire or an intrusion.

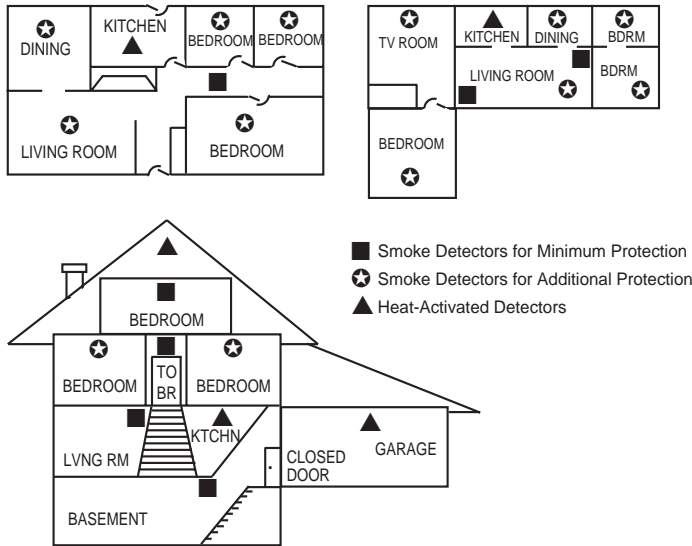

THIS CONTROL COMPLIES WITH NFPA REQUIREMENTS FOR TEMPORAL PULSE SOUNDING FOR FIRE NOTIFICATION APPLIANCES.

Recommendations For Proper Intrusion Protection

For proper intrusion coverage, sensors should be located at every possible point of entry to a home or commercial premises. This would include any skylights that may be present, and the upper windows in a multi-level building.

In addition, we recommend that radio backup be used in a security system so that alarm signals can still be sent to the alarm monitoring station in the event that the telephone lines are out of order (alarm signals are normally sent over the phone lines, if connected to an alarm monitoring station).

TABLE OF CONTENTS

Section 1.	GENERAL DESCRIPTION	9
Section 2.	INSTALLING THE CONTROL	11
	Mounting the Cabinet	11
	Installing the Lock (if used)	11
	Installing the Control's Circuit Board Alone or (if used), With a 4204 Relay Unit.....	11
	Installing Control and RF Receiver Circuit Boards Together in the Cabinet.....	13
	Standard Phone Line Connections	13
	Wiring the AC Transformer	14
	Installing the Back-Up Battery	14
	Earth Ground Connections	14
Section 3.	INSTALLING REMOTE KEYPADS	15
	Keypads that May Be Used	15
	Wiring to the Keypads	15
	Wiring Run Chart for Devices Drawing AUX Power From the Control.....	15
	Mounting the Keypads	16
	Using A Supplementary Power Supply To Power Additional Keypads.....	16
	Preliminary Check-Out Procedure	17
Section 4.	BASIC HARD-WIRED ZONES 1-6	18
	Installing the Hard-Wired Zones	18
	Common Characteristics For Zones 1-6.....	18
	Wiring Burglary and Panic Devices to Zones 1-6	18
	Wiring 4-Wire Smoke/Combustion Detectors on Zones 5	18
	Compatible 4-Wire Smoke/Combustion Detectors.....	19
	Programming Hard-Wired Zones.....	19
	Programming Panic Keys	20
	Check-Out Procedure for Hard-Wired Zones 1-6	21
Section 5.	WIRELESS (RF) ZONE EXPANSION (5700 & 5800 RF SYSTEMS)	22
	Wireless Systems Available	22
	Wireless System Operation and Transmitter Supervision	22
	Transmitter Battery Life	23
	Receiver Supervision.....	23
	Installation and Setup of the 4281/5881 Series Wireless Receivers	23
	Installing the 5800TM Module.....	24
	5700 Series Transmitter Setup	24
	Setting the DIP Switches on 5700 Series Wireless Transmitters.....	25
	Wireless Zone/ID Assignments for 5700 Series Transmitters	25
	DIP Switch Tables for 5700 RF System Wireless Devices	26
	Compatible 5700 Series Transmitters	27
	Programming the Control For a 5700 Wireless System	28
	Using the House ID Sniffer Mode (5700 Systems)	28
	Zone Programming for 5700 Series Transmitters.....	28
	Go/NoGo Test	30
	5800 Series Transmitter Setup	31
	5800 Series Transmitter Input Loops	31
	5800 Series Transmitter Input Types	31
	Compatible 5800 Series Transmitters	32
	Programming the RF Transmitters (5800 RF Systems)	33
	Enrolling 5800 Transmitters Into the System.....	34
	Enrolling Through Zone Programming (*56).....	34

Section 5.	WIRELESS (RF) ZONE EXPANSION (5700 & 5800 RF SYSTEMS), CONT'D	
	To Either Temporarily or Permanently Remove a Zone From the System (5800 System)	37
	Deleting a Transmitter Serial Number From a Zone in *56 Mode (5800 System)	37
	Check-out Procedure for Wireless Zones	37
	Transmitter ID Sniffer Mode (5700 RF Systems Only)	37
	Go/No Go Test Mode (5700 and 5800 RF Systems).....	37
Section 6	RELAY OUTPUT DEVICES	39
	Relay Device Basics	39
	4204 Relay Modules	39
	4204 Setup	39
	Supervision.....	39
	Programming Options Defined.....	39
	Programming Output Relays.....	41
	Example of Output Relay Programming	43
Section 7.	4285 PHONE MODULE	44
	Installing the Phone module.....	44
	General Information	44
	Mounting The Phone module.....	44
	Phone module Wiring	44
	Caller ID Units.....	45
	Programming The Control For Phone Access	47
	Checking the Operation of the 4285 Phone module	48
Section 8.	EXTERNAL SOUNDERS	49
	Compatible Sounders	49
	Sounder Connections	50
	Programming For External Sounders	50
	Testing the Sounder.....	50
Section 9.	LONG RANGE RADIO	51
	General Information	51
	Connection	51
	Programming for Long Range Radio	51
Section 10.	AUDIO ALARM VERIFICATION (AAV) UNIT	52
	General Information	52
	Wiring Connections	52
	Programming	52
Section 11.	FINAL POWER UP	54
	Earth Ground Connections.....	54
	AC Power-Up	54
	Connecting the Back-Up Battery	54
	Calculating the Battery Size Needed	54
	Making the Battery Connections	55
	Auxiliary Device Current Draw Worksheet	55
Section 12.	ALPHA DESCRIPTOR PROGRAMMING	56
	Assigning Zone Descriptors	56
	Entering Zone Descriptors (in program Menu Mode *82)	56
	Programming the Descriptors	56
	Alternate Method for Programming Zone Descriptors.....	58
	Adding Custom Words	59
	Alpha Vocabulary List (For Entering Zone Descriptors).....	60
	Character (ASCII) Chart	60

Section 13.	SEQUENTIAL MODE (For 5800 Series Wireless Transmitters)	61
Section 14.	SYSTEM COMMUNICATION	64
	Report Code Formats	64
	Table of Contact ID Event Codes	66
	Communication Programming	66
Section 15.	TESTING THE SYSTEM	71
	Test Procedure	71
	To the Installer	72
Section 16.	SYSTEM OPERATION	73
	Security Codes	73
	Installer Code	73
	Assigning the Master Code	73
	Changing the Master Code	73
	User Codes	73
	Duress Code	73
	Keypad Functions	74
	General Information	74
	Arming Functions	74
	Panic Keys	75
	4285 Phone module (if used)	75
	Relays Outputs (if used)	75
	Exit Alarm Displays (if programmed)	75
	Trouble Conditions	76
	General Information	76
	"Check" and "Battery" Displays	76
	Power Failure	76
	Other Displays	76
Section 17.	TROUBLESHOOTING GUIDE	77
	Contacting Technical Support	79
Section 18.	SPECIFICATIONS & ACCESSORIES	80
	Specifications	80
	Accessories (Compatible Devices)	82
	REGULATORY AGENCY STATEMENTS	83
	LIMITATIONS OF THIS ALARM SYSTEM	86
	SUMMARY OF CONNECTIONS DIAGRAM	<i>Inside Back Cover</i>
	LIMITED WARRANTY	<i>Back Cover</i>

NOTE: A separate Programming Guide is supplied with this manual.

LIST OF FIGURES

Figure 1.	Installing the Cabinet Lock	11
Figure 2.	Installing The PC Board Alone, or (if used), With a 4204 Relay Unit.....	12
Figure 3.	Installing the PC Board & RF Receiver Together in the Cabinet	12
Figure 4.	Standard Telephone Line Connections.....	13
Figure 5.	Keypad Connections to the Control Board.....	16
Figure 6.	Using a Supplementary Power Supply for Keypads	17
Figure 7.	4-Wire Smoke Detector Connections to Zone 5	18
Figure 8.	4281, 5881, and 5882 Wireless Receivers (cover removed)	24
Figure 9.	4204 Connections To Control	39
Figure 10.	4285 Phone module Wiring Connections.....	46
Figure 11.	Typical Sounder Wiring.....	50
Figure 12.	Long Range Radio Connections	51
Figure 13.	Connection of AAV Unit When Not Using a 4285 Phone module	53
Figure 14.	Connection of AAV Unit When Also Using a 4285 Phone module.....	53
Figure 15.	VISTA-10SE Summary of Connections Diagram.....	<i>Inside Back Cover</i>

HOW TO USE THIS MANUAL

This manual is written to accommodate both the new and the experienced installer of Ademco products. A general description of the entire system is located in the first section of this manual. This includes the various features available and the optional peripheral devices that the system can support.

This manual is divided into separate sections. A section covering the hardwired zones (1–6) provides complete information on the capabilities of each basic hardwired zone, including its usage, programming, and a checkout procedure. Separate sections are also provided for each peripheral device that can be used in the system and includes wiring setup, programming requirements, and a checkout procedure for that device. The checkout procedures ensure that the specific device is operational in the system before proceeding to the next section. This “sectional” arrangement is also particularly useful if you are making an addition to the system at a later time (e.g., adding Wireless zones, adding a 4285 Phone module, etc.).

Without an understanding of the programming method for this system, you will not be able to successfully perform the required programming. Before any programming is attempted, we therefore urge you to read the “Mechanics of Programming” and the “Data Field Descriptions” in the separate PROGRAMMING GUIDE that has been supplied.

If you are an experienced user of Ademco products, you may choose to wire and then program the entire system at one time. If so, refer to “Mechanics of Programming” and “Data Field Descriptions” in the separate PROGRAMMING GUIDE after the hardware setup is complete. The separate PROGRAMMING GUIDE contains all of the information you will need to program the system (including a blank Programming Form), except for detailed programming for hardwired zones 1–6 and the wireless zones, which are contained in the following sections in this manual: *BASIC HARDWIRED ZONES 1–6* and *WIRELESS (RF) ZONE EXPANSION (5700 & 5800 RF SYSTEMS)*.

This manual uses various icons to denote critical notes and technical tips to assist you with the installation of this system (see next page).

CONVENTIONS USED IN THIS MANUAL

MAIN SECTION TITLES ARE SHOWN IN REVERSE TYPE

UL

These notes include specific information which must be followed if you are installing this system for a UL Listed application.



These notes include information that you should be aware of before continuing with the installation, and which, if not observed, could result in operational difficulties.



This symbol indicates the presence of critical information that, if not observed, could seriously affect the operation of the system, or could cause damage to the system. Please read each warning carefully. This symbol also denotes warnings about physical harm to the installer.

Enter Zn Num.
(00 = Quit)

01

Many system options are programmed in an interactive menu mode by responding to Alpha keypad display prompts. These prompts are shown in a double-line box.

*00

When programming the system, data fields are indicated by a "star" [*] followed by the data field number.

PRODUCT MODEL NUMBERS: Unless noted otherwise, references to specific model numbers represent Ademco products.

Section 1. GENERAL DESCRIPTION

The VISTA–10SE is a control that supports up to 22 zones, using basic hard-wired, and/or wireless, plus remote keypads.

Basic Hardwired Zones (1–6)

Provides 6 basic hardwired zones having the following characteristics:

- Zones 1-6 response time is 300–500 milliseconds.
- Zone 3 programmable High Speed response time (10–15 milliseconds).
- EOLR supervision supporting N.O. or N.C. sensors
- Zone 5 supports as many 4-wire smoke or heat detectors as can be powered from the control).
- Zone 7, 95 and 96 are keypad Panics.
- Zone 8 Duress.
- Zone 9 Tamper.

Optional Expansion Zones (up to 16 total wireless zones)

Wireless Expansion:

- Supports up to 16 wireless zones.
- Requires the use of a 4281 type RF receiver (with 5700 series wireless transmitters) or 5881 (5882 in Canada) type RF Receiver (with 5800 series wireless transmitters), as shown below.

Receiver Model	No. of Zones	Transmitter Type
4281L (4281CN-L*)	Up to 4	5700
4281M (4281CN-M*)	Up to 8	5700
4281H (4281CN-H*)	Up to 8	5700
5881L (5882L*)	Up to 8	5800
5881M	Up to 16	5800
5881H (5882H*)	Up to 16	5800

* Used in Canada.

Remote Keypads

Up to 4 of any of the following keypads may be used:

Fixed-Word Keypads: **4127***, **4137AD**, **6127***, **6128**, and **6137**.

* These keypads cannot be used if the 4285 Phone module is being used.

Alpha Keypads: **5137AD**, **6139** (2-line alphanumeric displays).
6138 (1-line alphanumeric display).



For programming from a keypad, a 5137AD or 6139 2-line Alpha keypad must be connected (but need not necessarily stay in the system).

Security Codes

- One Master code for entire system (user 2). Installer code is user 1.
- 4 secondary user codes (users 3–6).
- One duress code (User 8).

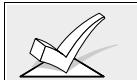

Duress Code: An emergency code which, when used to disarm or arm the system, will send a silent duress message to the central station.

Keypad Panic Keys

- Up to 3 programmable panic key functions are provided.
- Designated as Zones 95, 96, 7.
- Activated by wired & wireless keypads.
- Reported separately, distinguished by subscriber ID number.

Paging Feature

If the paging feature has been programmed for your system, your pager will respond to certain conditions as they occur in your system, and display code numbers indicating the type of condition that has occurred.

Quick Arm Feature

“Quick Arm” may be programmed, allowing use of the [#] key in place of the security code for arming (Quick Arm will not work unless the Master code has been programmed into the system).

- Optional Output Relays**
 - Up to 4 relays using one **4204 Relay Module**.
 - Actions programmable to respond to zone activity or manual keypad entries.
- Optional Phone module**
 - Supports the Ademco **4285 Phone module**.
 - Provides access to the system via on premises or off-premises phones for arming, disarming, etc., plus control of relay outputs.
- Optional Long Range Radio**
 - Allows all messages that have been programmed to go to the primary telephone number to be reported additionally to a 7720 PLUS or 7820 radio.
- Alarm Output**
 - Provides a 12VDC, 2 AMP output that can drive the compatible sounders listed in the EXTERNAL SOUNDERS section (assumes a fully charged battery is connected).
 - Steady output for Burglary/Panic, or temporal pulse sounding output for Fire notification, as required by UL.
 - Uses current limiting circuitry for protection.
- Auxiliary Power Output**
 - Provides 12VDC, 500mA maximum. Uses current limiting circuitry for protection.
 - This output interrupts for smoke detector reset if 4-wire smoke detectors are used.
- Programming**
 - Programmed options are stored in electrically erasable, non-volatile EEROM memory (information can be reprogrammed at any time and will not be lost in the event of a power loss).
 - The system can be uploaded, downloaded, or controlled via an IBM compatible computer, using either Ademco's V-Link[®] downloading software (Rev. 4 or higher) or Ademco's *Compass* Windows downloading software, and a HAYES modem specified by Ademco.

Keypad programming consists of:

 - Data field programming.
 - Interactive (menu) mode programming.



For programming from a keypad, a 5137AD or 6139 2-line Alpha keypad must be connected (but need not necessarily stay in the system).

- Communication Formats Supported**
 - Ademco Low Speed (Standard or Expanded).
 - Sescoa/Radionics (Standard or Expanded).
 - Ademco Express.
 - Ademco Contact ID.
- Zone Descriptors**

You can assign Alpha descriptors to all zones (useful only when using Alpha keypads and/or the 4285 Phone module).
- AC Power Supply**

Uses **No. 1321**, 120VAC plug-in transformer with 16.5VAC 25VA output. (1321CN in Canada)
- Back-Up Battery**
 - Rechargeable (Gel type) 12VDC, 4AH minimum.

Section 2. INSTALLING THE CONTROL

This section provides instructions for mounting the control cabinet, and installing the cabinet lock (if used). Also included in this section are instructions for the following:

- Installing the main PC board (and 4204 Relay Unit, if used).
- Mounting the RF Receiver board (if used) in the cabinet.
- Standard phone line connections.
- Installing the back-up battery in the cabinet.
- Connecting the AC transformer.
- Making earth ground connections.

Mounting the Cabinet

Mount the control cabinet to a sturdy wall using fasteners or anchors (not supplied), in a clean, dry area which is not readily accessible to the general public. Four mounting holes are provided at the back of the cabinet.

If an RF Receiver is being used and you intend to mount its PC board within the cabinet, note the following:

- Do not mount the cabinet on or near metal objects. This will decrease RF range and/or block RF transmissions from wireless transmitters.
- Do not locate the cabinet in an area of high RF interference (revealed by frequent or prolonged lighting of the LED in the receiver after it is operational). Random flicker is OK.

Installing the Lock (if used)

Use an Ademco No. N6277 Cam Lock and No. N6277-1 Push-On Clip (Retainer Clip).

Note: The cabinet can be closed and secured *without* a lock by using 2 screws in the cover's edge.

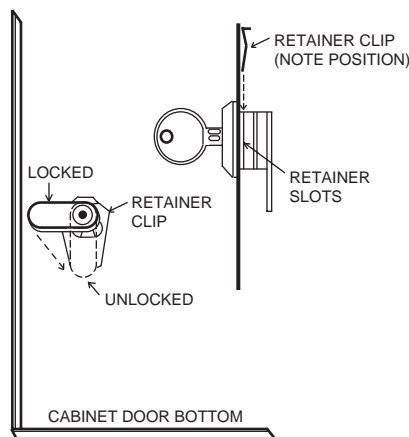

Figure 1. Installing the Lock

1. Remove the cabinet door. *It is easily removable for servicing and is easily re-installed.*
2. Remove the lock knockout from the control cabinet door. Insert the key into the lock. Position the lock in the hole making certain that the latch will make contact with the latch bracket when the door is closed.
3. Hold the lock steady, and insert the retainer clip into the retainer slots. Position the clip as illustrated in order to permit easy removal.



Before installing the cabinet's contents, remove the metal cabinet knock-outs required for wiring entry. Do not attempt to remove the knockouts after the circuit board has been installed.

Installing the Control's Circuit Board Alone, or (if used), with a 4204 Relay Unit

Control's Circuit Board

1. Hang two *long Red* mounting clips (provided) on the raised cabinet tabs (see Detail B in Fig. 2).
2. Insert the top of the circuit board into the slots at the top of the cabinet. Make sure that the board rests on the correct row (see Detail A in Fig. 2).
3. Swing the base of the board into the mounting clips and secure the board to the cabinet with the accompanying screws (see Detail B in Fig. 2).

**4204 Relay Unit
(if installed in cabinet)**

1. Insert self-tapping screws (provided) in two adjacent raised cabinet tabs. Leave the heads projecting 1/8".
2. Hang the unit on the screw heads via two of the slotted holes at the rear of its housing, as shown in Figure 2.
3. The 4204's cover can be left off if the unit's DIP switch is set with its position 1 "ON" (to the right) as shown in its instructions. The tampered cover is necessary for installations outside of the control's cabinet.

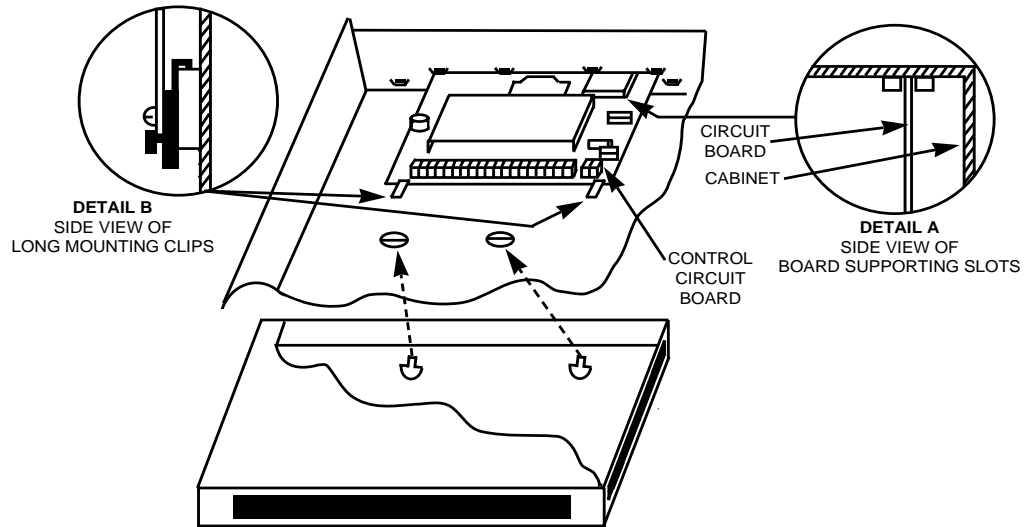

Figure 2. Installing The PC Board in the Cabinet Alone, or (if used), With a 4204 Relay Unit

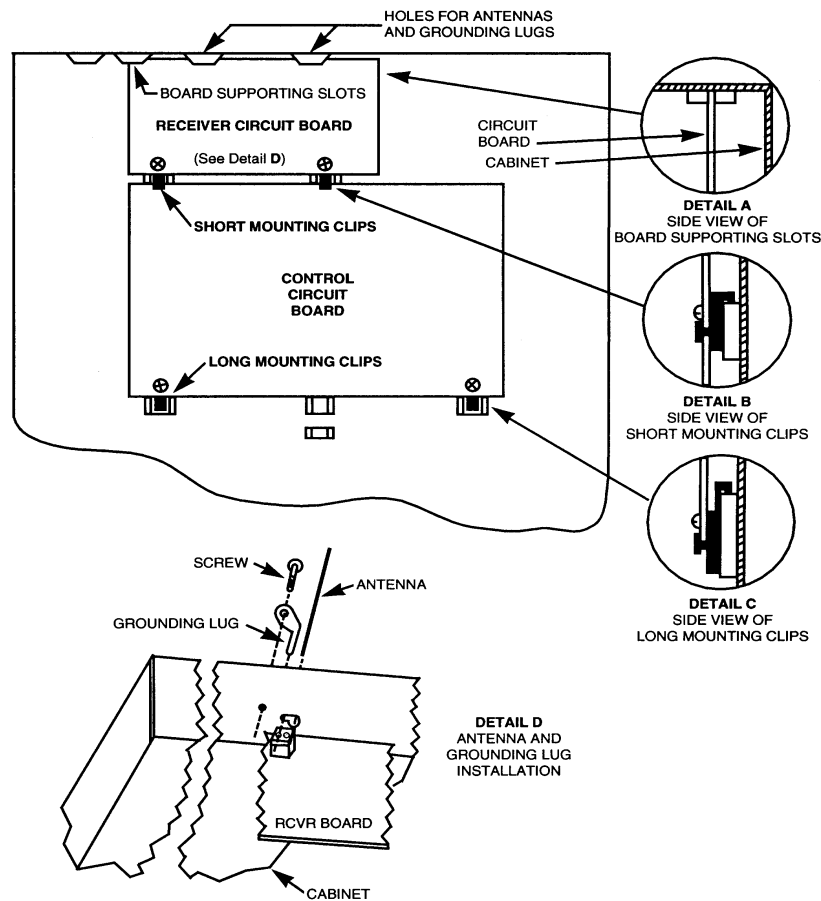
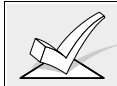

Figure 3. Installing The PC Board And RF Receiver Together In The Cabinet

Installing the Control and RF Receiver Circuit Boards Together in the Cabinet

1. Hang two *short* (black) mounting clips (provided with receiver) on the raised cabinet tabs, as shown in Detail B in Figure 3.
2. Insert the top of the receiver board (removed from its own case as described in *its* instructions) into the slots at the top of the cabinet, as shown in Detail A in Figure 3. Make sure that the board rests on the correct row of tabs, as shown.
3. Swing the base of the board into the mounting clips and secure it to the cabinet with the accompanying screws (see Detail B in Fig. 3).
4. Insert the top of the control's board into the slot in the clips and position two *long* (red) clips at the lower edge of the board (see Detail C).
5. Swing this board into place and secure it with two additional screws.
6. Insert grounding lugs (supplied with the receiver) through the top of the cabinet into the *left-hand* terminals of the antenna blocks (at the upper edge of the receiver board) and secure them to the cabinet top with the screws provided, as shown in Detail D.
7. Insert the receiver's antennas through the top of the cabinet, into the blocks' *right-hand* terminals, and tighten the screws.
8. Setup and wiring of the receiver. is contained in the WIRELESS (RF) ZONE EXPANSION (5700 & 5800 RF SYSTEMS) section.

Standard Phone Line Connections



The wiring connections shown here are not applicable if the 4285 Phone module is used. Refer to the 4285 Phone module section for information regarding phone line connections, which are different than those shown here.

Incoming phone line and handset wiring is connected to the main terminal block (via a RJ31X jack) as indicated below and shown in Figure 4.

Term. 17: Local Handset (TIP – Brown*).

Term. 18: Local Handset (RING – Gray*).

Term. 19: Incoming Phone Line (TIP – Green*).

Term. 20: Incoming Phone Line (RING – Red*).

* Colors of wires in Direct Connect Cord.

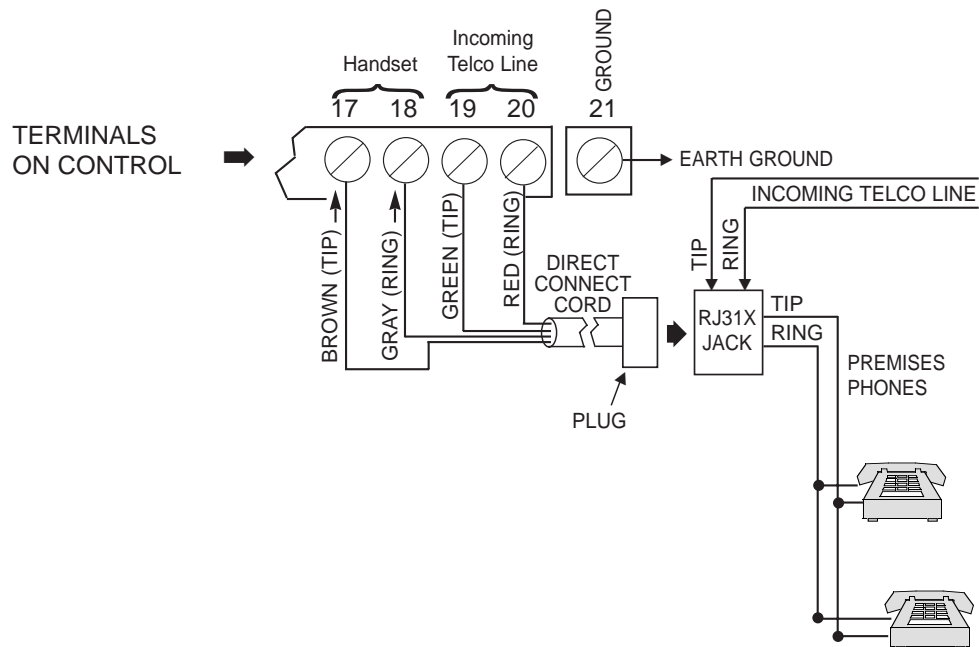



Figure 4. Standard Telephone Line Connections

Wiring The AC Transformer

No. 1321 Wire the No. 1321 transformer to terminals **1** and **2** on the control board. See wiring table below for wire gauge to use.

WIRING TABLE	
Distance of Transformer From the Control Panel	Wire Gauge To Use
Up to 50 feet	# 20
50–100 feet	# 18
100–250 feet	# 16

 Wiring to the AC Transformer must not exceed 250 feet using 16 gauge wire. Do not plug the transformer into the AC outlet until you are instructed to do so later in the manual.

Installing The Back-Up Battery

 Do not attach the connector cable to the battery terminals until you are instructed to do so later in the manual.

1. Place the 12-volt back-up battery in the control cabinet.
2. Attach Red and Black wires on the battery connector cable to the control board as follows: †
 - a. Red to the positive (+) battery tab **on the control board** (see Summary of Connections Diagram for location, if necessary).
 - b. Black to the negative (–) battery tab **on the control board**.

† These wires may have already been connected to the battery tabs on the control board. If so, disregard steps a. and b.

DO NOT CONNECT THE WIRES TO THE BATTERY YET!

 Use a 4AH battery or larger for UL installations.

Earth Ground Connections

The designated earth ground terminal (**21**), must be terminated in a good earth ground for the lightning transient protective devices in this product to be effective. The following are examples of good earth grounds available at most installations:

Metal Cold Water Pipe:

Use a non-corrosive metal strap (copper is recommended) firmly secured to the pipe to which the ground lead is electrically connected and secured.

AC Power Outlet Ground:

Available from 3-prong, 120VAC, power outlets only. To test the integrity of the ground terminal, use a three-wire circuit tester with neon lamp indicators, such as the UL-Listed Ideal Model 61–035, or equivalent, available at most electrical supply stores.

Section 3. INSTALLING REMOTE KEYPADS

This section lists the wired keypads that may be used and provides instructions for wiring and mounting the keypads.

A preliminary check-out procedure is also provided to ensure that the connected keypads are functioning properly in the system.

Keypads That May Be Used

- Fixed-Word Display: 4127, 4137AD, 6127, 6128, 6137
- Alpha Display: 5137AD, 6138, 6139
- Up to 4 keypads, independent of auxiliary power considerations (you may need to use an auxiliary power supply if the 500mA aux. output is exceeded)



If you are going to use a 4285 Phone module, you **MUST** use addressable keypads (4137AD, 5137AD, 6128, 6137, 6138, 6139) in the system, but set to the non-addressable mode (address 31).

Wiring To The Keypads

1. Determine wire gauge by referring to the wiring length/gauge chart below.
For devices (Keypads, RF Receivers, etc.) connected to a single 4-wire run, determine the current drawn by all units connected to the single wire run, then refer to the Wiring Run chart to determine the maximum wire length that can be safely used for each wire size. Current draw for all devices can be found in the *SPECIFICATIONS AND ACCESSORIES* section.

Note: Refer to "Auxiliary Device Current Draw Worksheet" in the *FINAL POWER UP* section for current draw for all keypads.



Maximum wire lengths for any device that is homerun to the control can also be determined from the chart, based on the current draw of that device alone.

Wiring Run Chart For Devices* Drawing Aux Power From The Control (12V+ & 12V-)

Wire Size	TOTAL CURRENT DRAWN BY ALL DEVICES CONNECTED TO A SINGLE WIRE RUN			
	50mA or less	100mA	300mA	500mA
#22	500 ft (152m)	250 ft (76m)	80 ft (24m)	50 ft (15m)
#20	750 ft (228.6m)	380 ft (116m)	130 ft (39.6m)	80 ft (24m)
#18	1300 ft (396m)	650 ft (198m)	220 ft (67m)	130 ft (39.6m)
#16	1500 ft (457m)	1000 ft (305m)	330 ft (100.5m)	200 ft (70m)

* Includes Keypads, RF Receivers, Relay Units, or 4285 Phone module.



The length of all wire runs must not exceed 1500 feet (457m) when unshielded quad conductor cable is used (750 feet if shielded cable is used). This restriction is due to the capacitive effect *on the data lines* when quad cable is used.

2. Run field wiring from the control to the keypads (using standard 4-conductor twisted wire cable using the wire gauge determined in step 1).
3. Connect remote Keypads to terminals 4, 5, 6, and 7 on the control board, as shown in Figure 5.

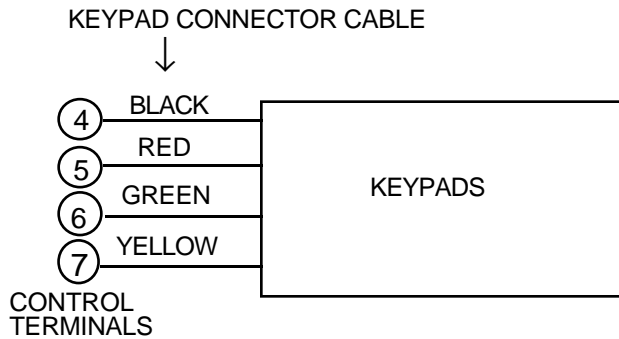

Figure 5. Keypad Connections To The Control Board

Mounting the Keypads

1. **Make sure addressable type keypads** (4137AD, 5137AD, 6128, 6137, 6138, and 6139) are set to non-addressable mode (address 31), which is the factory default setting. Refer to the instructions provided with the keypad for address setting procedure.
2. **Mount the keypads** at a height that is convenient for the user. Refer to the instructions provided with the keypad for mounting procedure.
You can either surface mount or flush mount keypads (using an appropriate Trim Ring Kit: 5137TRK or 6139TRK). Refer to the mounting instructions and template included with the keypad and/or trim ring kit for specific information.

Using a Supplementary Power Supply to Power Additional Keypads

The control provides 500mA for powering keypads (up to a maximum of 4) and other devices from the auxiliary power output. The backup battery will supply power to these keypads in the event that AC power is lost.

When the control's auxiliary power load for all devices exceeds 500mA, you can power additional keypads from a regulated, 12VDC power supply (e.g., 487-12 supplies 12V, 250mA; 488-12 supplies 12V, 500mA). Use a UL Listed, battery-backed supply for UL installations.

The 487-12/488-12 power supplies have a backup battery which can power these keypads in the event of AC power loss.

	<p>Keypads powered from supplies which do not have a backup battery will not function when AC power is lost. Therefore, be sure to power at least one keypad from the Control's auxiliary power output.</p>
--	--

Connect the additional keypads as shown in Figure 6, using the keypad wire colors shown. Be sure to observe the current ratings for the power supply used.

	<p>Make connections directly to the screw terminals as shown in Figure 6. Make no connection to the keypad blue wire (if present). Be sure to connect the negative (–) terminal on the Power Supply unit to terminal 4 (AUX –) on the control.</p>
--	---

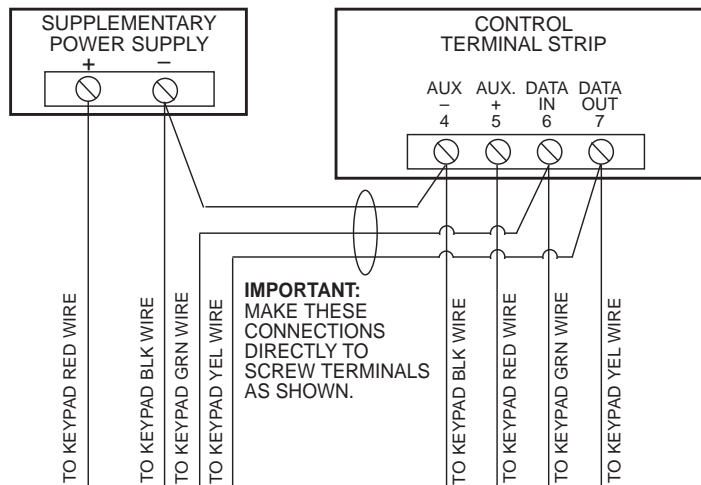

Figure 6. Using A Supplementary Power Supply For Keypads

Preliminary Check-out Procedure

If you want to check that the system is working before connecting field wiring from zones and devices, do the following:

1. Temporarily connect a 1000 ohm end-of-line resistor across each of the basic hard-wire zones 1–6, as shown in the Summary of Connections diagram.

Without actual zone wiring or EOL resistors connected, the keypads in the system will not display the “Ready” message.

2. Power up the system temporarily by plugging the AC transformer (previously wired to the control) into a 120VAC outlet.
3. **Busy – Standby** (Alpha keypads) or **dl** (Fixed-word keypads) will be displayed.

After approximately 1 minute*, the green “READY” LED (or “POWER” LED on some types of keypads) should light, and the word READY (Fixed-word keypads), or DISARMED...READY TO ARM (Alpha keypads) should be displayed.

* To bypass the 1-minute delay, press # plus 0.

If the “Ready” message is not displayed on any of the keypads in the system, or a “Not Ready” message is displayed, check the keypad wiring connections, and make sure each of the 6 basic hard-wired zones has a 1000 ohm resistor connected across its terminals.

4. When you get the proper “Ready” displays on the keypad(s), the system is functioning properly at this point.

Do not remove the EOL resistors until you are ready to make connections to the hard-wired zones, to allow for testing later in the manual.



If an OC or OPEN CIRCUIT display is present on the keypad, data from the control is not reaching the keypad. Check the wiring.

Section 4. BASIC HARD-WIRED ZONES 1-6

This section provides general information for the hard-wired zones in the system, plus specific instructions for installing 4-wire smoke/combustion detectors.

Also included is a procedure for programming the hard-wired zones.

Installing the Hard-Wired Zones

Common Characteristics for Zones 1-6

- Response time from 300 –500 milliseconds (400 milliseconds nominal).
- Zone 3 can be programmed (in field *52) for normally closed sensor fast response (10 msec max) to an open (suitable for vibration type contacts). Default response is 400 msec nominal, which should be used for most standard contacts.
- EOLR supervised zones support both open-circuit & closed-circuit devices.
- As many 4-wire smoke detectors as can be powered from Aux Power on the control (on zone 5).

Wiring Burglary and Panic Devices To Zones 1-6

1. Connect sensors/contacts to the hard-wired zone terminals (8 through 16). See the Summary of Connections diagram .
2. Connect closed circuit devices in series in the high (+) side the loop. The EOL resistor must be connected in series with the devices, following the last device. See the Summary of Connections diagram.
3. Connect open circuit devices in parallel across the loop. The 1,000 ohm EOLR must be connected across the loop wires *at the last device*.



If the EOLR is not at the end of the loop, the zone will not be properly supervised, and the system may not respond to an open circuit on the zone.

Wiring 4-Wire Smoke/Combustion Detectors on Zone 5.

The system will support as many 4-wire detectors as can be powered from Auxiliary Power on the control on zone 5. Refer to the detector's instructions for complete details regarding its proper installation and operation.

1. Connect 12 volt power for the detectors from Auxiliary Power terminals **4** and **5**, (which will interrupt power for fire alarm reset). Observe proper polarity when connecting detectors. See Figure 7.
2. Connect detectors (including heat detectors, if used) across terminals of zone 5. All detectors must be wired in parallel.



Remove 1000 ohm EOL resistor if connected across the zone terminals. You must connect the EOL resistor across the loop wires at the last detector.

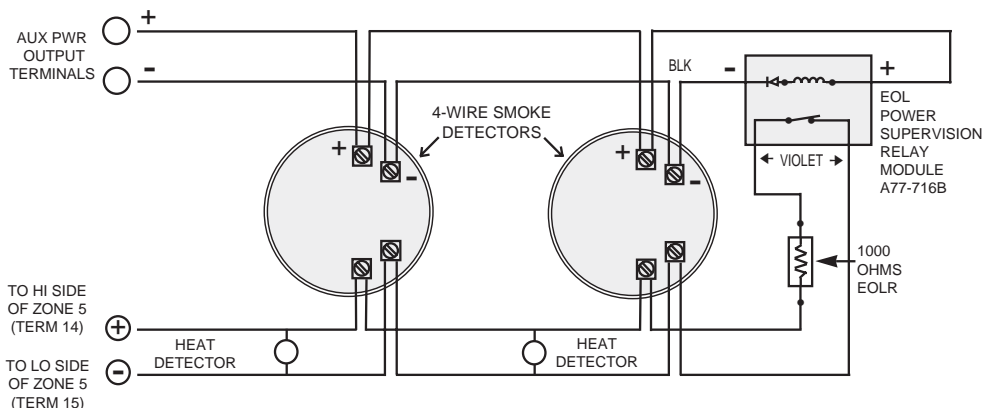



Figure 7. 4-wire Smoke Detector Connections (Zone 5.)

Compatible System Sensor 4-Wire Smoke/Combustion Detectors

1412	4-wire ionization products of combustion detector.
2412	4-wire photoelectric smoke detector.
2412TH	4-wire photoelectric smoke detector w/135°F (57°C) heat detector.
A77-716B	EOL relay module (supervisory module for wired 4-wire fire zone).
2112/24T	Low-profile 4-wire photoelectric smoke detector w/135°F (57°C) heat detector.

Programming Hard-Wired Zones

1. With at least one 2-line Alpha keypad (5137AD or 6139) connected to the keypad terminals on the control, power up the system temporarily. If you had previously connected the AC transformer to the control panel, you need only plug in the transformer (to 120VAC outlet) to power up the system.
2. Enter the programming mode by keying the following on the Alpha keypad:
INSTALLER code (4 1 1 1) + 8 + 0.

	Data fields *22 RF SYSTEM, and *25 OUTPUT RELAY MODULE must be programmed as required before continuing.
---	--

3. **Press *56.** Note that this is an interactive programming mode. You will use it to program zone numbers, zone types, and alarm report codes for hard-wired zones (and RF zones).

Note: If you enabled the 5800 wireless system in field *22 (a "2" entry), the first screen prompt will be **"Program Tool?... 0 = No 1 = Yes"**. Enter "0" (No). The next prompt will ask you to enter zone number.

Enter Zn Num. (00 = Quit) 01
--

Zone Number ↑

Enter the first zone number that you wish to program (or [0][0] to exit zone programming). If you are starting with zone 1, leave as is **and press [*] to continue.**

If programming another zone, enter the desired zone number, 02, 03, etc. (zone 02 is shown in the next display). **Press [*] to continue.**

Typical summary display

Zn	ZT	-	RC	In	L
02	03	-	00	HW:	-

A summary display will appear, showing the present status of that zone's programming.

Zn = zone number;
ZT = zone type;
RC = report code for that zone;
In = input type of zone.

Values displayed are currently programmed values.

If it is programmed satisfactorily, press [#] to back up one step and enter the next zone number, if desired.

If you want to change a zone's programming, press [*]. A prompt for Zone Type will appear.

↓ Zone Number

02 Zone Type Perimeter 03

Zone Type ↑

Each zone must be assigned a zone type, which defines the way in which the system responds to faults in that zone. A detailed explanation of each zone type is provided in "Response Type Definitions" in the *ZONE RESPONSE TYPE DEFINITIONS* section in the **Programming Guide.**

Enter the desired zone type code, as listed next. The example on the left shows zone type "03", Perimeter, entered.

Zone Types

00 = Zone Not Used	08 = 24 Hr Aux
01 = Entry/Exit #1	09 = Fire
02 = not used	10 = Interior w/Delay
03 = Perimeter	20 = Arm Stay*
04 = Interior Follower	21 = Arm-Away*
05 = Trouble Day/Alarm Night	22 = Disarm*
06 = 24 Hr Silent	23 = No Alarm
07 = 24 Hr Audible	Response

* 5800 RF Systems only

When the display shows the zone type you want, press [*] to continue.



You must enter "00" as the **zone type** for any hard-wired zones that are not used.

02 Report Code
1st 03 2nd 12 3C

The report code consists of 2 hexadecimal digits, each in turn consisting of 2 numerical digits. For example, for a report code of "3C", enter [0][3] for "3" and [1][2] for "C". Refer to the *SYSTEM COMMUNICATION* section for complete information on report codes, if necessary.

Enter the desired report code and then press [*] to continue.

Typical summary display

Zn	ZT	-	RC	In	L
02	03	-	3C	HW:	-

A summary display will appear, showing the data for the zone that was just programmed.

If it is programmed satisfactorily, press [*] to continue.

Program Alpha?
0 = No 1 = Yes 0

The next request is to enter Alpha descriptors for the zones. The entry may be done now (enter 1), or may be done at a later time using *82 interactive mode (enter 0). See the *ALPHA DESCRIPTOR PROGRAMMING* section for specific procedure.

Enter Zn Num.
(00 = Quit) 03

If "0" (no) was entered above, the system will return to the Enter Zone Number prompt. Proceed with the programming for the next zone, i.e., [*] and zone number.

Enter next zone number ↑

Programming Panic Keys

When programming zones, note the following:

The **defaults** for individual panic keys or panic key pairs are:

Zone 07. * & #, or B: zone type 06 (24-hr silent).

Zone 95. 1 & *, or A: zone type 00 (not used).

Zone 96. 3 & #, or C: zone type 00 (not used).

Panic keys are programmed (or re-programmed) by keying the zone number, e.g., *07, *95, and *96, and entering the desired zone type that will provide the desired panic function for each of these keys, using the list of zone types below.

06 = 24 Hr Silent
07 = 24 Hr Audible
08 = 24 Hr Aux
09 = Fire

When you have programmed all the hard-wired zones and Panic keys satisfactorily, exit *56 interactive mode at the **Enter Zn Num.** prompt by entering [0][0] as the next zone number.

Then exit the programming mode by keying *99.

See the special notes below, then proceed to the check-out procedure that follows.

Special Notes on Zone Programming:

- *In field *56, at the summary line for each zone, the entered values can be checked.* If you wish to change anything, press [#] to move to the previous entry. Press [#] a number of times to move to earlier entries. Press [*] to move to later entries again.
- *Zone entries can be reviewed* by pressing [#][5][6]. Changes cannot be made here, so this is safer for review. Enter the first zone number to be viewed and press [#]. To view each zone, press [#] and the zone number will advance to the next programmed zone. When the end of the list is reached, press [0][0] to exit. This method of exiting may also be done at any time during the review.
- *To either temporarily or permanently remove a zone from the system, go into programming mode and press [*][5][6].* Enter the zone number and press [*]. At the Zone Type prompt, enter [0][0] and [*]. This sets the type of the zone to Not Used. The next prompt will be "Delete Zone?". "Yes" will permanently remove the zone from the system while "No" will disable it but retain all data except the original zone type. You can then go back to this zone later and put back an active Zone Type to re-enable it.

Check-Out Procedure For Hard-Wired Zones

After installation of all hard-wired devices is completed, the security system should be checked, as follows.

1. Make certain that all devices and sensors connected to the hard-wired zones are not in a faulted state. Doors and windows with contacts should be closed, PIRs should be covered (use a cloth to mask them temporarily if necessary).
2. Plug in the AC Transformer if you have not already done so..
3. With all hard-wired zones intact, the Alpha keypad connected to the system should display:

*** DISARMED ***
READY TO ARM

If the following is displayed,

DISARMED Press *
to show faults

press the [*] key to display the faulted zone(s). Restore any faulted zone(s) as necessary (also make sure that you have connected a 1000 ohm EOL resistor across the terminals of unused zones).

When the **DISARMED...READY TO ARM** message is displayed, you can proceed to the next step.

4. Fault and then restore every contact or sensor on each zone individually to ensure that it is being monitored by the system. Each time a zone is faulted, the keypad should display the number of the faulted zone. When each zone is restored, the **READY TO ARM** message should appear again.
5. When you get the proper displays on the keypad(s), the hard-wired zones in the system are functioning properly.

Section 5. WIRELESS (RF) ZONE EXPANSION (5700 AND 5800 RF SYSTEMS)

This section provides the following information:

- Wireless systems available.
- Installing the wireless receiver.
- Installing the 5800TM Module.
- Programming for the wireless receiver.
- Setup and installation of the wireless transmitters (5700 or 5800 series).
- Programming the wireless transmitters (5700 or 5800 series).
- Checkout procedure for wireless zones (test modes).

UL

Wireless may not be used in UL Commercial Burglary installations.

Wireless Systems Available

The VISTA-10SE supports wireless zones which may be used exclusively, or in addition to hardwire zones 1 through 6. The system supports two different wireless systems which have many similarities, but notable differences in the programming of the transmitters for each system.

The following receivers may be used with this system and each supports the number of zones shown:

TABLE 1

5700 Series		5800 Series	
Receiver	Wireless Zones	Receiver	Wireless Zones
4281L/4281CN-L†	up to 4	5881L/5882L†	up to 8
4281M/4281CN-M†	up to 8	5881M	up to 16
4281H/4281CN-H†	up to 8	5881H/5882H†	up to 16

† 4281CN and 5882 type receivers are for use in Canada. See special note below.

	<p>In Canada, 5700 systems must use 4281CN series receivers (4281CN-L, 4281CN-M, or 4281CN-H) (with Canadian versions of 5700 type transmitters). 5800 systems must use 5882 series receivers (5882L or 5882H). Information in this manual relative to the 4281 series of receivers applies as well to the 4281CN series. Information relative to the 5881 series of receivers applies as well to the 5882 series. 5881 and 5882 series receivers can use the same transmitters (5800 type).</p>
---	---

	<p>Any zone <i>number</i> from 10–63 can be used as a 5700 or 5800 series wireless zone (do not confuse this with the number of zones that can be used, which is shown in Table 1 above).</p>
---	---

Wireless System Operation and Transmitter Supervision

The receiver responds to status and alarm signals from wireless transmitters [operating at 345MHz for 5700 series in USA (315MHz in Canada), and 345 MHz for 5800 series (in USA and Canada)] within a nominal range of 200 feet; the receiver then relays this information to the control.

Except for transmitters that may be carried off-premises (such as the 5700 system's 5701 and 5727, the 5800 system's 5802, 5802CP, 5804, and 5827, and either system's 5827BD), each transmitter is supervised by a check-in signal that is sent to the receiver at 70–90 minute intervals. If at least one check-in is not received from each *supervised* transmitter within a 12-hour period, the "missing" transmitter number(s) and "CHECK" will be displayed on the keypad.

The supervision for a particular transmitter in the 5800 system may be turned off by entering it as a "UR" (unsupervised RF) type, as described later.

5800 series transmitters have built-in tamper protection and will cause a "CHECK" condition to be annunciated if covers are removed.

Each transmitter is also supervised for low battery and will transmit a low battery signal to its receiver, with the battery having at least 30 days of life remaining. A low battery message and appropriate zone number will appear on a wired keypad's display.

If a 5727, 5827, or 5827BD wireless keypad has a low battery, it will be displayed as Zone "00" when it transmits.

Note: After a low or dead battery is replaced, activate the transmitter and then enter the security code + OFF to clear the system's memory of the "Low Battery" signal.

Transmitter Battery Life

- Batteries in the wireless transmitters may last from 4-7 years, depending on the environment, usage, and the specific wireless device being used. External factors such as humidity, high or low temperatures, as well as large swings in temperature may all reduce the actual battery life in a given installation. The wireless system can identify a true low battery situation, thus allowing the dealer or user of the system time to arrange a change of battery and maintain protection for that given point within the system.
- Some transmitters (e.g., 5802, 5802CP) contain long-life but non-replaceable batteries. At the end of their life, the complete unit must be replaced (and a new serial number entered into the control).
- Button type transmitters (e.g., 5802, 5802CP, 5804) should be periodically tested by the user for battery life.

Receiver Supervision

The receiver itself is supervised. A tamper report (zone 9) will be generated:

- a) If communication with the receiver is interrupted
or
- b) If valid RF signals are not received within 12 hours from at least one *supervised* wireless transmitter (if any are included in the system)

Wireless System Installation Advisories

Disregard the following advisories if the receiver is mounted in the control cabinet as described in the INSTALLING THE CONTROL section.

1. Place the receiver in a high, centrally located area for best reception. Do not place receiver on or near metal objects. This will decrease the range and/or block transmissions. Do not mount receivers or transmitters in an attic, where extreme temperatures could prevent proper operation.
2. The house IDs must be entered for the receiver (applies only to 5700 RF system or if using a 5827/5827BD wireless keypad in a 5700 **or** 5800 RF system).

Installation and Setup of the 4281/5881 Wireless Receivers

1. Mount the receiver(s) if not installed previously in the control cabinet, as indicated in the *INSTALLING THE CONTROL* section. Receivers can detect signals from transmitters within a nominal range of 200 feet. Take this into consideration when determining mounting location outside of the cabinet.
2. Make sure that the receiver's DIP switches are set for device address "0", as shown in Figure 8 (all switches to the right...OFF).
3. Connect the receiver's wire harness to the control's keypad terminals (4, 5, 6, and 7). Plug the connector at the other end of the harness into the receiver (see Figure 8).
4. Refer to the receiver's installation instructions for further installation instructions regarding antenna mounting, etc.

NOTE: WHEN CIRCUIT BOARD IS MOUNTED IN CONTROL'S CABINET, GROUNDING LUGS (2) PROVIDED MUST BE INSERTED IN LEFT-HANDTERMINALS OF ANTENNA BLOCKS AND SECURED TO CABINET (SEE RECEIVER'S AND CONTROLS INSTRUCTIONS)

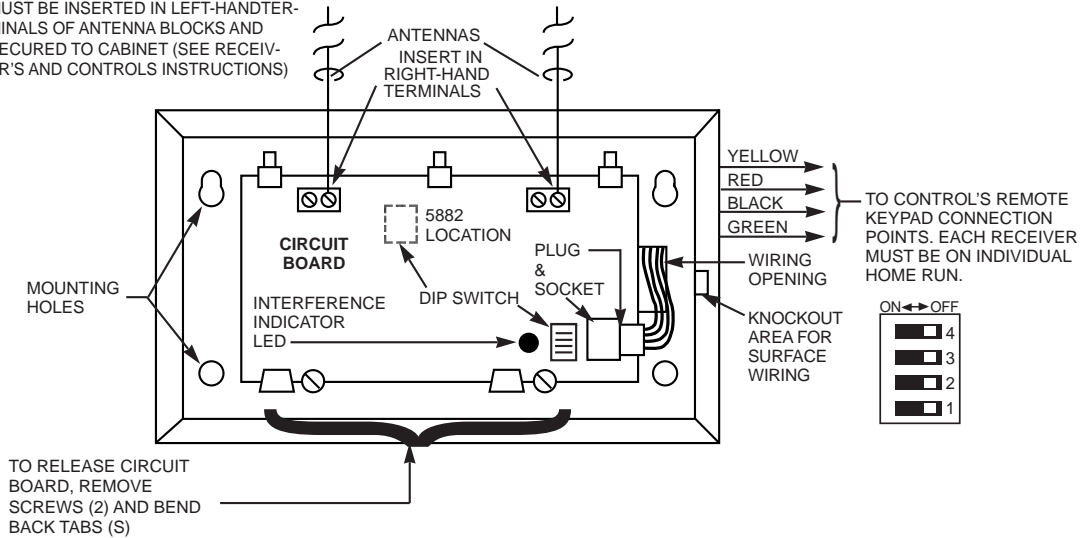

Figure 8. 4281, 5881, & 5882 Series Wireless Receivers (cover removed)

Installing the 5800TM Module

Installation of this module is necessary only if you are using one or more 5827BD Wireless Bi-directional keypads.

The 5800TM must be located between one and two feet from the 4281 or 5881 receiver's antennas. *The 5800TM must not be installed within the control cabinet.* Mount the unit using its accompanying mounting bracket.

5800TM Wiring Connections

Connect the 5800TM to the control panel's keypad connection terminals, using the supplied connector with flying leads, as follows:

WIRE	TERMINAL ON CONTROL
RED (+12VDC)	Terminal 5
BLACK (Ground)	Terminal 4
GREEN (Data to Control)	Terminal 6
YELLOW (Data from Control)	Terminal 7
BLUE: Not Used	

Do not cut any of the jumpers on the 5800TM when using it with the VISTA-10SE.

For additional information, refer to the 5800TM's instructions.

5700 Series Transmitter Setup

Each 5700 series transmitter has DIP switches to set both the transmitter's zone number (Transmitter zone/ID) and the system House ID. The House ID will be the same for all transmitters and must match the House ID programmed into the system (in data field *24) for the wireless receiver. This can be likened to a family in which everyone has the same last name (House ID), but each person has a different first name (Transmitter zone/ID). The zone/ID number must then be programmed into the system using *56 interactive mode.

A variety of wireless transmitters can be used to make up the wireless zones. These include window/door units, smoke detectors, PIRs, and panic buttons. Zone/ID number assignments can be from **10-63**. Remember, the 5700 system supports up to 8 wireless zones, depending on the RF receiver used (see Table 1 previously).

Setting the DIP Switches on 5700 Series Transmitters

Set the DIP switches on each 5700 series transmitter to the appropriate zone/ID number and House ID. Refer to the **Compatible 5700 Series Transmitters** table on a following page in this section for zone numbers and programming information for each particular transmitter. Refer also to DIP SWITCH TABLES FOR 5700 RF WIRELESS DEVICES later in this section.

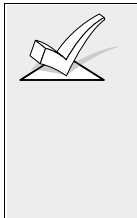

The House ID allows the 5700 RF system to identify 5700 transmitters with a matching House ID. If using a 5700 RF wireless system, the DIP switches on the transmitters must match the system House ID programmed into the control (in data field *24). *If using a 5827BD wireless keypad, the House ID also applies.* Other than the 5827 and 5827BD, 5800 series devices do not communicate by House ID, but by transmitting a unique serial number to the control. In this case, programming a House ID is not necessary.

Wireless Zone/ID Assignments for 5700 Series Transmitters

Each wireless zone can be assigned any zone response type, such as Entry/Exit Burg, Interior Follower, Perimeter, etc. (see the *ZONE RESPONSE TYPE DEFINITIONS* section in the separate **Programming Guide** for a detailed explanations of each zone type). For 5700 series transmitters, each response type uses a certain range of zone numbers. Each range of zone/ID numbers is shown below.

<u>Zone Type</u>	<u>Transmitter Zone/ID #</u>
Entry/Exit Burg	10 through 47 *
Perimeter Burg	10 through 47 *
Interior Burg	10 through 47 * 32 through 47 * (5775)
Fire	48 through 63 * 48 through 55 ** (5706)
24 Hour Panic	48 through 63 *
(silent or audible)	62 or 63 *** (5701)
Day/Night Burglary	10 through 47 *
24 Hour Auxiliary	10 through 47 *

* Zone/ID numbers 10–63 can be used, but you should note the following in connection with certain transmitter zone/IDs identified as follows:

** Transmitter IDs 48 through 55 have highest signal priority.

*** Transmitter IDs 62 and 63 are unsupervised to allow removal of the 5701 off premises — signal priority is lower than that of fire, but higher than burglary.

Notes:

1. Transmitters set for zone/IDs 48–55 (FIRE) will transmit once every 12 seconds while the zone is faulted. Transmitters set for zone/IDs 56–63 will transmit once every 3 seconds while faulted. These two ranges of zone/ID numbers have high signal priority and their frequent transmissions while faulted ensure re-triggering of the alarm until the cause is removed. Bear in mind that because of this, transmitter battery life could be shortened.
2. Transmitters set for an zone/IDs of 32 through 47 will have a 3-minute lock-out between transmissions. Use this range of zone/ID numbers for sensors protecting frequently used doors or windows to conserve battery life.
3. Refer also to “Compatible 5700 Series Transmitters” on a following page.

DIP SWITCH TABLES FOR 5700 RF SYSTEM WIRELESS DEVICES

HOUSE ID SWITCH SETTING FOR ALL DEVICES EXCEPT 5716

DEVICE ID	DIP SWITCH POSITION				
	1	2	3	4	5
1	UP	UP	UP	UP	—
2	UP	UP	UP	—	UP
3	UP	UP	—	UP	—
4	UP	UP	—	UP	UP
5	UP	UP	—	—	UP
6	UP	UP	—	—	UP
7	UP	UP	—	—	—
8	UP	—	UP	UP	UP
9	UP	—	UP	UP	—
10	UP	—	UP	—	UP
11	UP	—	UP	—	—
12	UP	—	—	UP	UP
13	UP	—	—	UP	—
14	UP	—	—	—	UP
15	UP	—	—	—	—
16	—	UP	UP	UP	UP
17	—	UP	UP	UP	—
18	—	UP	UP	—	UP
19	—	UP	UP	—	—
20	—	UP	—	UP	UP
21	—	UP	—	UP	—
22	—	UP	—	—	UP
23	—	UP	—	—	—
24	—	—	UP	UP	UP
25	—	—	UP	UP	—
26	—	—	UP	—	UP
27	—	—	UP	—	—
28	—	—	—	UP	UP
29	—	—	—	UP	—
30	—	—	—	—	UP
31	—	—	—	—	—

BIT VALUE: 16 8 4 2 1

5701 PANIC TRANSMITTER

HOUSE ID (1 SHOWN)

POS.6 UP = XMTR ID 62
DN = XMTR ID 63

5706/5707 SMOKE DETECTOR/TRANSMITTER

HOUSE ID (1 SHOWN)

XMTR ID (48 SHOWN)

XMTR ID	DIP SWITCH POSITION
48	UP UP UP
49	UP UP —
50	UP — UP
51	UP — —
52	— UP UP
53	— UP —
54	— — UP
55	— — —

5775 PIR DETECTOR/TRANSMITTER

HOUSE ID (1 SHOWN)

XMTR ID (32 SHOWN) UP = PULSE COUNT
— = INST. MODE

XMTR ID	DIP SWITCH POSITION
32	UP UP UP UP
33	UP UP UP —
34	UP UP — UP
35	UP UP — —
36	UP — UP UP
37	UP — UP —
38	UP — — UP
39	UP — — —
40	— UP UP UP
41	— UP UP —
42	— UP — UP
43	— UP — —
44	— — UP UP
45	— — UP —
46	— — — UP
47	— — — —

5727 KEYPAD

HOUSE ID (1 SHOWN)

XMTR ID FIXED AT "00"

5715 UNIVERSAL TRANSMITTER

POS.1: UP = NORMAL RESPONSE
DN = FAST RESPONSE

POS. 2: UP = NO COVER TAMPER
DN = COVER TAMPER (use N.C. setting)

5711/5711WM DOOR/WINDOW TRANSMITTER

HOUSE ID (1 SHOWN)

XMTR ID (33 SHOWN)

POS.12: UP = N.O.
— = N.C. (Avoid ID 32-37 with N.O.)

XMTR ID	DIP SWITCH POSITION
1	UP UP UP UP UP —
2	UP UP UP UP — UP
3	UP UP UP UP — —
4	UP UP UP — UP UP
5	UP UP UP — — UP
6	UP UP UP — — —
7	UP UP — UP UP UP
8	UP UP — UP UP —
9	UP UP — — UP UP
10	UP UP — — — UP
11	UP — UP — UP —
12	UP UP — — UP UP
13	UP UP — — — UP
14	UP UP — — — —
15	UP UP — — — —
16	— UP UP UP UP —
17	— UP UP UP — UP
18	— UP UP — UP —
19	— UP UP — — UP
20	— UP — UP — UP
21	— UP — UP — —
22	— UP — — UP —
23	— UP — — — UP
24	— — UP UP UP —
25	— — UP UP — UP
26	— — UP UP — —
27	— — — UP UP —
28	— — — UP — UP
29	— — — — UP UP
30	— — — — — UP
31	— — — — — —
32	UP UP UP UP UP —
33	— UP UP UP UP —
34	— UP UP UP — UP
35	— UP UP — UP UP
36	— UP UP — — UP
37	— UP — UP UP —
38	— UP — UP — —
39	— UP — — UP —
40	— — UP UP UP —
41	— — UP UP — UP
42	— — UP — UP —
43	— — UP — — UP
44	— — — UP UP —
45	— — — UP — UP
46	— — — — UP —
47	— — — — — UP
48	— — — — — —
49	— — — — — —
50	— — — — — —
51	— — — — — —
52	— — — — — —
53	— — — — — —
54	— — — — — —
55	— — — — — —
56	— — — — — —
57	— — — — — —
58	— — — — — —
59	— — — — — —
60	— — — — — —
61	— — — — — —
62	— — — — — —
63	— — — — — —

BIT VALUE: 32 16 8 4 2 1

5716 DOOR/WINDOW TRANSMITTER

IMPORTANT SET SWITCHES WITH BATTERY REMOVED

SW4 SW3

UP SW41

UP SW31

POS. 6: UP = N.O.
DN = N.C.

TRANSMITTER ID	DIP SWITCH POSITION
1	— UP UP UP UP UP
2	UP — UP UP UP UP
3	— UP UP UP UP UP
4	UP UP — UP UP UP
5	— UP — UP UP UP
6	UP — — UP UP UP
7	— — — UP UP UP
8	UP UP — — UP UP
9	— UP UP — — UP
10	UP — — — UP UP
11	— — — — UP UP
12	UP UP — — — UP
13	— UP — — — UP
14	UP — — — — UP
15	— — — — — UP
16	UP UP UP UP — —
17	— UP UP UP — —
18	UP — UP UP — —
19	— — UP UP — —
20	UP UP — — — —
21	— UP — — — —
22	UP — — — — —
23	— — — — — —
24	UP UP UP — — —
25	— UP UP — — —
26	UP — UP — — —
27	— — UP — — —
28	UP UP — — — —
29	— UP — — — —
30	UP — — — — —
31	— — — — — —
32	UP UP UP UP UP —
33	— UP UP UP UP —
34	— UP — UP UP —
35	— — UP UP UP —
36	— UP — — UP —
37	— — UP — — —
38	— — — UP — —
39	— — — — UP —
40	UP UP UP — — —
41	— UP UP — — —
42	UP — UP — — —
43	— — UP — — —
44	UP UP — — — —
45	— UP — — — —
46	UP — — — — —
47	— — — — — —
48	UP UP UP UP — —
49	— UP UP UP — —
50	UP — UP UP — —
51	— — UP UP — —
52	UP UP — — — —
53	— UP — — — —
54	UP — — — — —
55	— — — — — —
56	UP UP UP — — —
57	— UP UP — — —
58	UP — UP — — —
59	— — UP — — —
60	UP UP — — — —
61	— UP — — — —
62	UP — — — — —
63	— — — — — —

BIT VALUE: 1 2 4 8 16 32

For 5700 series transmitters not shown in this table, refer to the instructions accompanying each transmitter.

Compatible 5700 Series Transmitters

Model	Product	Zone/ID #	Description
5701	Panic Transmitter	62 or 63	<ul style="list-style-type: none"> • Programmable for either silent or audible 24-hour alarm.
5706	Photoelectric Smoke Detector	48–55	<ul style="list-style-type: none"> • One-piece smoke detector with built-in transmitter. • Built-in UL Listed 85dB piezo electric alarm sounder and audible low battery warning.
5711	Slimline Door/Window Transmitter	10–63	<ul style="list-style-type: none"> • Can be used with any closed or open circuit sensor.
5715WH	Universal Transmitter	10–63	<ul style="list-style-type: none"> • DIP switch selectable for fast response, and open or closed sensor usage. • Has a tamper protected cover.
5716 5716WM	Door/Window Transmitter	10–63	<ul style="list-style-type: none"> • Can be used with any open or closed circuit sensor. • Features a built-in reed switch. • 5716WM includes magnet.
5742	Audio Discriminator	10–63	<ul style="list-style-type: none"> • For use in unoccupied areas to detect the sound of shattering glass when a window is broken.
5743	Dual Technology Glassbreak Detector	10–63	<ul style="list-style-type: none"> • Detects the sound <i>and</i> shock of breaking glass and requires the presence of <i>both</i> to initiate an alarm condition.
5775	PIR Detector	32–47	<ul style="list-style-type: none"> • Dual element passive infrared detector with built-in selectable pulse count. <p><i>Note:</i> There is a 3-minute lock-out between fault transmissions to conserve battery life.</p>
5727	Wireless Keypad	House ID	<ul style="list-style-type: none"> • Can be used to turn the burglary protection on and off. • Features the same built-in panic functions as wired keypads. • Identified as zone "00" (on wired keypads) when it transmits with a low battery.
5827BD	Wireless Keypad (usable in a 5700 System)	House ID	<ul style="list-style-type: none"> • Requires use of 5800TM Module. • RF House ID must be programmed in field *24, and the wireless keypad set to the same ID. • Operates the system similarly to wired keypads • Can indicate system status via its 3 LEDs and sounder. • Includes 3 panic keys.
5799	Magnets		<ul style="list-style-type: none"> • Package of 8 magnets for use with 5716 transmitters

UL	<p>The 5711, 5715, and 5716 do not supervise their loop wiring for shorts. Therefore, for UL Household Burglary installations, the loop wiring may not exceed 3 feet.</p>
-----------	---

Programming the Control For a 5700 Wireless System

1. With at least one two-line Custom English keypad wired and set to address 31 (default), power up the system temporarily by plugging the AC transformer (previously wired to the control) into a 120VAC outlet.
2. Enter data field programming mode: **Installer Code + 8 + 0.**
3. Set data field *22 (RF SYSTEM TYPE) to "1" (5700)
4. Enter the House ID (01–31) in data field *24. (RF HOUSE ID CODE)
The House ID entered in this field will identify 5700 series transmitters in a 5700 RF system (all 5700 type transmitters are set for the same House ID).
If a 5827BD wireless keypad is to be used in a 5700 RF system, the same House ID code entered in this field must also set on the 5827BD wireless keypad(s).
5. Exit the programming mode by keying *99.

The DIP switches in each 5700 series transmitter that is going to be used in the system must be set to the appropriate zone/ID number and House ID. Refer to "Setting the DIP Switches On 5700 Series Transmitters" and "Wireless Zone/ID Assignments for 5700 Series Transmitters" on a previous page, if necessary.

The system House ID must have been programmed in data field *24, and the DIP switches on all transmitters set for the same ID. If using a 5827BD wireless keypad, the House ID also applies.

Note: The 5827BD is keypad programmable; the 5727 wireless keypad is programmed via its DIP switches. Refer to the instructions supplied with the 5827BD and 5727 for details.

Batteries should be installed in all transmitters.

Using the House ID Sniffer Mode (5700 Systems)

4281 series RF receivers respond only to 5700 transmitters (and 5827BD wireless keypads) set to the same House ID (01–31) programmed into the control panel. This prevents system interference from transmitters in other nearby systems. Using the House ID Sniffer Mode will make sure you have not chosen a House ID that is in use in a nearby system.

1. Enter your **Installer Code + # + 2** .
2. The receiver will now "sniff" out any House IDs in the area and display them. Keep the receiver in this mode for about 2 hours to give a good indication of the House IDs being used. Be sure you have used a House ID that is *not displayed*.
3. To exit the Sniffer Mode, simply enter your **Installer Code + OFF** .

	Since the Sniffer Mode effectively disables wireless point reception, Sniffer Mode cannot be entered while the system is armed.
---	--

	Do not permanently mount the transmitters yet; a Go/No Go test (described later) must be performed after programming is completed to make sure reception of each transmitter's signal at the proposed mounting location is adequate.
---	--

Zone Programming For 5700 Transmitters

Before proceeding, each of the 5700 transmitters in the system should have been assigned a unique Zone/ID number via its DIP switches, and this information marked on the back of the transmitter. "Wireless Zone/ID Assignments for 5700 Series Transmitters" on a previous page provides information concerning the assignment of Zone/ID numbers to transmitters.

1. With a 2-line Custom English keypad connected to the keypad terminals, power up the system temporarily. If you had previously connected the AC transformer to the control panel, you need only plug the transformer in (to 120VAC outlet) to power up the system.
2. Enter the programming mode by keying: **Installer Code + 8 + 0.**

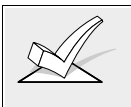

Data field *22 RF SYSTEM TYPE, must have been programmed for a 5700 RF system ("1"). Also, the House ID should have been entered in field *24, and all 5700 transmitters set to the same House ID.

4. Press *56. (Zone Programming Mode)

Use this mode to program zone numbers, zone types, and alarm report codes for all 5700 wireless zones that are going to be used in the system.

5700 transmitters are programmed into the system one at a time, starting with the lowest Zone/ID number that has been assigned to it previously via its DIP switches.

Example: If the first transmitter to be programmed has been set via its DIP switches to Zone/ID 20, you will program zone types, and alarm report codes for that transmitter in zone 20.

Enter Zn Num.
(00 = Quit) 20

Zone 20 entered ↑

Zn ZT - RC In: L
20 00 - - - : -

↓ Zone Number

20 Zone Type
Perimeter 03

Entry for Zone Type
03 shown

A detailed explanation of each zone type is provided in the *ZONE RESPONSE TYPE DEFINITIONS* section in the separate **Programming Guide**.

20 Report Code
1st 03 2nd 12 3C

20 Input Device
RF Trans. RF:

5. Enter the zone number that you wish to program. As an example, zone 20 is shown entered here.

Zone *numbers* between 10 and 63 can be assigned to transmitters. However, the total number of wireless zones that can be used is 8 for 5700 RF systems (see Table 1 on a previous page).

6. A summary display will appear, showing the status of that zone's program.

If it is programmed satisfactorily, press [#] to back up one step and enter another zone number, if desired.

If the zone is not programmed, or you want to change it, press [*]. A prompt for Zone Type will appear.

7. Each zone must be assigned a zone type, which defines the way in which the system responds to faults in that zone.

Enter the zone type (or change it, if necessary). Zone types that you can assign are listed below. Enter the desired zone type code as listed.

- | | |
|------------------------------|-----------------------|
| 00 = Zone Not Used | 07 = 24 Hr Audible |
| 01 = Entry/Exit Burglary | 08 = 24 Hr Aux |
| 03 = Perimeter | 09 = Fire |
| 04 = Interior Follower | 10 = Interior w/Delay |
| 05 = Trouble Day/Alarm Night | 23 = No Alarm |
| 06 = 24 Hr Silent | Response |

When the display shows the zone type you want, press [*] to continue.

8. Enter the report code.

The report code consists of 2 hexadecimal digits, each in turn consisting of 2 numerical digits. For example, for a report code of "3C", enter [0][3] for "3" and [1][2] for "C".

See the *SYSTEM COMMUNICATIONS* section for complete information on report codes, if necessary.

Press [*] to continue.

9. For the hardwired zones (HW), and the zones for a 5700 system's transmitters (RF), the Input Device types are automatically assigned (Panic, Duress, and Tamper inputs are not applicable).

10. Mark the zone number on the transmitter.
11. After the transmitter has been entered into the system, press [*] to continue.

Typical summary display

Zn	ZT	-	RC	In:	L
20	03	-	3C	RF:	-

Program Alpha?					
0 = No 1 = Yes 0					

Enter Zn Num.	
(00 = Quit)	21

A summary of the programmed values for the selected zone will now be displayed
If all is okay, press [*] for the next display.

Alpha descriptors for the zones can be done now, or may be done at a later time using *82 interactive mode (enter "0").
Refer to *ALPHA DESCRIPTOR PROGRAMMING* section for performing this procedure in the *82 interactive menu mode.

If "0" (no) was entered in response to the Program Alpha? question, a prompt will then be displayed for entry of the number for the next wireless zone to be programmed.

12. Proceed with the programming of the next wireless zone, starting at step 5 again.
13. To exit field *56 when completed, key [0][0] at the "Enter Zone Number" prompt.
14. Exit the programming mode by keying *99.

Special Notes on Zone Programming (5700 RF Systems)

- *In field *56, at the summary line for each zone, the entered values can be checked.* If you wish to change anything, press [#] to move to the previous entry. Press [#] a number of times to move to earlier entries. Press [*] to move to later entries again.
- *Zone entries can be reviewed* by pressing [#][5][6]. Changes cannot be made here, so this is safer for review. Enter the first zone number to be viewed and press [#]. To view each zone, press [#] and the zone number will advance to the next programmed zone. When the end of the list is reached, press [0][0] to exit. This method of exiting may also be done at any time during the review.
- *To either temporarily or permanently remove a zone from the system, go into programming mode and press [*][5][6].* Enter the zone number and press [*]. At the Zone Type prompt, enter [0][0] and [*]. This sets the type of the zone to Not Used. The next prompt will be "Delete Zone?". "Yes" will permanently remove the zone from the system, while "No" will disable it but retain all data except the original zone type. You can then go back to this zone later and put back an active Zone Type to re-enable it.

Go/No Go Test

Before mounting transmitters permanently, conduct Go/No Go tests to verify adequate signal strength and reorient or relocate transmitters if necessary. During this mode, wireless receiver gain is reduced by 50%. Testing in this mode assists in determining good mounting locations for the transmitters and verifies that the RF transmission has sufficient signal amplitude margin for the installed system.

1. Enter the **Installer Code + # + 4**
2. Once transmitters are placed in their desired locations and the approximate length of wire to be run to sensors is connected to the transmitter's screw terminals, fault each transmitter. *Do not conduct this test with your hand wrapped around the transmitter as this will cause inaccurate results.*
 - The keypad will beep three times to indicate signal reception.

- If the keypad does not beep, re-orient or move the transmitter to another location. Usually a few inches in either direction is all that is required.
3. Mount the transmitter according to the instructions provided with the transmitter.
 4. Exit the GO/NO GO test mode by entering **Installer Code + (OFF)**.

You should now proceed to “**Check-Out Procedure for Wireless Zones**” at the end of this section.

5800 Series Transmitter Setup

General Information

5800 series transmitters have built-in serial numbers that must be entered (“enrolled”) into the system using the *56 or *83 interactive mode, or input to the control via the downloader. 5800 series transmitters (except 5827 described separately) do not have DIP switches.

5800 Series Transmitter Input Loops

Each transmitter's zone number is programmed into the system in *56 mode. Some transmitters, such as the 5816 and 5817, can support more than one "zone" (referred to as loops or inputs). On the 5816 for example, the wire connection terminal block is loop 1, the reed contact is loop 2. Each loop must be assigned a different zone number and entered separately.

For button transmitters (wireless "keys"), such as the 5804, you must assign a unique zone number to each individual button used on the transmitter. Each button on the transmitter also has a pre-designated loop or input number, which is displayed when entered.

Refer to *5800 Series Transmitter Input Loop Identification* in the separate Programming Guide manual

UL	The 5816, and 5817 do not supervise their loop wiring for shorts. Therefore, for UL Household Burglary installations, the loop wiring may not exceed 3 ft.
-----------	--

	Programming an RF House ID (01–31) in field *24 is necessary only if using 5827 or 5827BD wireless keypads . An RF House ID is not necessary for other 5800 series transmitters and the entry should be left at “00” (default) in those cases.
---	---

The 5827 wireless keypad reports low battery status as zone "00."

5800 Series Transmitter Input Types

All of the transmitters described have one or more unique factory assigned loop inputs. *Each of the inputs requires its own programming zone* (e.g., a 5804's four button inputs require four programming zones).

5800 Transmitters can be entered into the system as one of the following input device types:

<i>Input Device Type</i>	<i>Description</i>
"RF" (Supervised RF)	Sends periodic check-in signals, as well as fault, restore, and low battery signals. The transmitter must remain within the receiver's range.
"UR" (Unsupervised RF)	Sends all the signals that the "RF" type does, but the control does not supervise the check-in signals. The transmitter may therefore be carried off-premises.
"BR" (Unsupervised Button RF)	These send only fault signals. They do not send low battery signals until they are activated. The transmitter may be carried off-premises.

	Do not install batteries in wireless transmitters until ready to use, as will be indicated under “Programming the RF Transmitters (5800 RF Systems)” later in this section. Though it is not critical to remove batteries after entering into the system, it is recommended in order to avoid interference while entering additional transmitters into the system.
---	--

Compatible 5800 Series Transmitters

<i>Model</i>	<i>Product</i>	<i>Enter As Input Device Type</i>	<i>Description</i>
5801	Wireless Panic Transmitter	UR or RF	<ul style="list-style-type: none"> • Has four pushbuttons, each with a unique input (loop) code. • Programmable responses (e.g., Panic, Arm–Stay, Arm–Away, Disarm, etc).
5802	Pendant (Personal Emergency Transmitter)	BR Only	<ul style="list-style-type: none"> • Has single pushbutton. • Usually programmed for response type of 24-Hr Audible or 24-Hr Silent (other zone responses are possible). • Contains a non-replaceable battery. At the end of the battery's life, the entire unit must be replaced.
5802CP	Belt Clip (Personal Emergency)	BR Only	Same as 5802.
5802MN	Miniature (Personal Emergency Transmitter)	UR or RF	<ul style="list-style-type: none"> • Has single pushbutton. • Usually programmed for a response type of 24-Hr. Audible or 24-Hr. Silent (other zone responses are possible).
5804	Wireless Key Transmitter	BR Only	<ul style="list-style-type: none"> • Has four pushbuttons, each with a unique input (loop) code. • Programmable responses (e.g., Arm–Stay, Arm–Away, Disarm, etc.).
5806 5807	Wireless Photoelectric Smoke Detectors	RF	<ul style="list-style-type: none"> • One-piece smoke detectors with a built in transmitter.
5808	Wireless Photoelectric Smoke Detector	RF	<ul style="list-style-type: none"> • One-piece smoke detectors with a built in transmitter. • Has built-in thermal circuitry to detect temperatures above 135°F, and tamper switch on base.
5816	Door/Window Transmitter:	RF	<ul style="list-style-type: none"> • Has two unique input (loop) codes: one for a wired closed circuit contact loop; the other for a built-in reed switch (used in conjunction with a magnet).
5816 TEMP	Low Temperature Sensor	RF	<ul style="list-style-type: none"> • Transmits a fault condition when temperature drops below 45 °F.
5817	Multi-Point Universal Transmitter	RF	<ul style="list-style-type: none"> • Has three unique input (loop) codes: one for a "Primary" contact loop with programmable options; the others for two "Auxiliary" closed circuit contact loops.

UL

The 5816 and 5817 do not supervise their loop wiring for shorts. Therefore, for UL Household Burglary installations, the loop wiring may not exceed 3 feet.

Compatible 5800 Series Transmitters (Continued)

<i>Model</i>	<i>Product</i>	<i>Enter As Input Device Type</i>	<i>Description</i>
5819	Shock Processor Transmitter	RF	<ul style="list-style-type: none"> Connects to externally mounted inertia-type shock detector (not supplied). Has built-in tampered cover switch. Has 3 unique input (loop) codes: <i>Loop 1:</i> Terminals for a wired, N.C. sensor loop. <i>Loop 2:</i> For a closed circuit contact loop using the built-in reed switch in conjunction with a magnet. <i>Loop 3:</i> Terminals for a wired, closed circuit contact loop.
5827	Wireless Keypad	House ID	<ul style="list-style-type: none"> Can be used to turn the burglary protection on and off. Features the same built-in panic functions as wired keypads. The keypad is identified as zone "00" on wired keypads when it transmits with a low battery.
5827BD	Wireless Two-Way Keypad (used with 5800TM)	House ID	<ul style="list-style-type: none"> Operates the system similarly to wired keypads. Can indicate system status via its 3 LEDs and sounder. Includes 3 panic keys. House ID must be set. Requires 5800TM Transmitter Module.
5850 (GBD)	Glass Break Detector	RF	<ul style="list-style-type: none"> Requires both sound and shock of breaking glass to cause alarm to be transmitted.
5890	PIR Detector	RF	<ul style="list-style-type: none"> Dual element passive infrared detector/transmitter with selectable pulse count. <p>Note: There is a 3-minute lock-out between fault transmissions to conserve battery life.</p>
5899	Magnets		Package of 4 magnets for use with 5816 and 5817 transmitters.

Programming the RF Transmitters (5800 RF Systems)

- With at least one 2-line Alpha keypad connected to the keypad terminals, power up the system temporarily. If you had previously connected the AC transformer to the control panel, you need only plug the transformer in (to 120VAC outlet) to power up the system.
- Enter the programming mode by keying: **Installer Code + 8 + 0**.



Data field *22 RF SYSTEM TYPE, must have been programmed for a 5800 RF system before continuing ("2" entered in that field).

(Continued)

3. *24. RF HOUSE ID CODE

The House ID identifies a 5827 or 5827BD Wireless keypad if it is used (enter 01–31). The wireless keypads should be set to the same ID. If no wireless keypad is to be used, leave as “00”.

Enrolling 5800 Transmitters Into The System

There are two methods that may be used to enroll transmitters. The first method is performed in *56 zone programming mode (which is contained in this section) and describes how to enroll each transmitter into the system as you are entering the zone information.

The second method is called "sequential enrollment", which uses *83 mode (contained in the *SEQUENTIAL MODE* section later in this manual). This section describes how to enroll all the transmitters into the system *after all zone information has been entered*.

As an option, the zone programming and sequential modes allow you to use a 5803 or 5804 **button-type** transmitter as a "program tool." The upper left-hand and right-hand buttons of the "tool" duplicate the * and # keypad programming functions (left = * , right = #). The advantage of using a program tool is that it enables remote enrolling. You can move to the physical location of the transmitter to be enrolled, press the upper left-hand button of the program tool, and then trip the intended transmitter (see step 10 for operation).

The transmitter that you use as the program tool can also be used as a transmitter in the system. If you plan to use an existing transmitter, it must first be enrolled into the system as its associated zones. You may then program it as the tool.

	Batteries can remain in the transmitters after the transmitters have been enrolled into the system. However, to prevent possible problems, make sure these transmitters are not faulted while other transmitters are being enrolled. Wireless motion detectors should be covered or placed face down to prevent transmissions.
---	--

Enrolling Through Zone Programming (*56)

1. Enter Programming mode [**Installer Code**] + 8 + 0.

Enter Zone Programming by pressing *56. If the system has been set up to use 5800 series RF, and a program tool has been entered, skip to step 4. If no program tool has been entered, the following prompt will appear:

Program Tool? 0 = No, 1 = Yes 0

2. If a program tool is being used, enter "1." If not using a tool, enter "0" and skip to Step 4.

00 Input S/N: L A X X X-X X X X

3. If "1" is entered, the system will prompt for the unit's serial number. Enter the program tool's serial number using one of the following methods:

a) Enter the 7-digit serial number for the transmitter

or

b) Press any button on the transmitter. The keypad should beep twice and display the serial number of the tool.

00 Input S/N: L A123-4567 3

In this example, the serial number is A123-4567. Once enrolled, the upper left-hand button of the program tool can be pressed to ready the system for enrolling a transmitter into the system.

Pressing the [#] key on the keypad will cause the system to back up to the "Program Tool ?" prompt.

The serial number for the program tool will only remain in the system until the programming mode is exited. (Entering *97 will not delete the tool.)

Press [*] to continue.

Enter Zn Num. (00 = Quit) 10

4. Enter the zone number that you wish to program. As an example, zone 10 is shown here.

Press [*] to continue.

Zone 10 entered ↑

ZN ZT – RC In: L
10 00 – 00 RF: 1

↓ Zone Number

10 Zone Type
Perimeter 03

Entry for Zone Type 03
shown

10 Report Code
1st 03 2nd 12 3C

10 Input Dev: LP #
Rf Trans. RF: 1

10 Input Dev: LP#
RF Trans. RF: 1

10 Learn S/N?
0 = No, 1 = Yes 0

10 Input S/N: L
A X X X-X X X X

5. A display will appear, showing a summary of that zone's programming. If the zone is not programmed, the display will appear as shown here. If checking a zone's programming, and it is programmed satisfactorily, press [#] to back up one step and enter another zone number, if desired. Otherwise, press [*] to continue.

6. Each zone must be assigned a zone type, which defines the way in which the system responds to faults in that zone. Enter the zone type desired (or change it, if necessary). Available zone types are:

- | | |
|------------------------------|------------------------|
| 00 = Zone Not Used | 08 = 24 Hr Aux |
| 01 = Entry/Exit #1, Burglary | 09 = Fire |
| 02 = Not used | 10 = Interior w/Delay |
| 03 = Perimeter | 20 = Arm–Stay* |
| 04 = Interior Follower | 21 = Arm–Away* |
| 05 = Trouble Day/Alarm Night | 22 = Disarm* |
| 06 = 24 Hr Silent | 23 = No Alarm Response |
| 07 = 24 Hr Audible | (EX: Relay activation) |

* These are special zone types used with 5800 series wireless pushbutton units which will result in arming the system in the STAY or AWAY mode, or disarming of the system, depending on the selection made. A button programmed for these functions will report the zone number of the button as the user number that armed/disarmed to the central station.

Press [*] to continue.

7. Enter the report code. The report code consists of 2 hexadecimal digits, each in turn consisting of 2 numerical digits. For example, for a report code of "3C", enter [0][3] for "3" and [1][2] for "C."

(Refer to the *SYSTEM COMMUNICATION* section for more information about report codes and report code formats.)

Press [*] to continue.

8. Enter the transmitter input device type as follows:

- 3 = RF (supervised RF transmitter)
- 4 = UR (unsupervised RF transmitter)
- 5 = BR (button type RF transmitter - unsupervised)

(Refer to the separate **Programming Guide** for input types.)

Press [*] to continue.

9. The cursor should now be flashing above the loop number. The default is "1." To accept this, press [*]. If a different loop number is being used on this transmitter, enter the loop number (1–4) and press [*] to continue (see the loop designations for various transmitters in the separate Programming Guide). **The loop number must be entered here, whether using Zone Programming or Sequential Mode to "enroll" transmitters.**

10. If the transmitter's serial number has not been previously "enrolled," you may enter the enroll mode now by either entering "1" (Yes) **or** by pressing the upper left-hand button of the "program tool". **If using the program tool, move to the physical location of the transmitter to be enrolled before pressing the button.** A single short beep will verify that the button has been pressed. The system will respond to the first serial number transmitted after the [*] key on the keypad or the button of the program tool is pressed.

Enter "0" (No) if you wish to enroll the transmitter later, using the "sequential" mode in Section 13. SEQUENTIAL MODE .

If "0" (No) is entered, go to step 13 (skip steps 11 and 12).

11. This prompt is displayed if "1" (Yes) is entered in response to the "Learn S/N?" prompt. The serial number may be enrolled by one of two methods:

- a) Enter the 7-digit serial number printed on the transmitter using a Alpha keypad, **or**
- b) Activate the transmitter by faulting **or** restoring the input you wish to use for that zone (e.g., press a button, open or close a door, etc.).

10 Input S/N: L
A002-4064 1

The system will enroll the serial number of the first transmitter heard, add the loop number entered to this serial number, display the serial and loop numbers, and cause the keypad to beep twice.



If the serial and loop number combination is already present in the system, a single long beep will be heard from the keypad. If this happens, the system will not display the serial number, but will wait for a transmission from another transmitter or transmitter loop input.

12. The system will then enter an optional confirmation mode so that the operation of the actual programmed input can be confirmed. Activate the loop input or button that corresponds to this zone. **We recommend that you confirm the programming of every transmitter before proceeding to the next zone.**

10 Confirmed
A022- 4064 1

When the system sees activity on the appropriate input, it will beep three times and display the confirmation message.



At any time during this step, you may press the [*] key on the keypad or the upper left-hand button of the program tool if you are satisfied with the serial and loop number combination that has been enrolled, regardless of whether or not the enrolled input has been "confirmed."

If the incorrect transmitter has been enrolled, press the # key on the keypad or the upper right-hand button of the program tool to delete the serial number and return to the "Learn S/N" prompt. A single long beep will be heard from the keypad to verify pressing of the upper right-hand button. Then, press "1" (Yes) or press the upper left-hand button of the program tool (a single short beep will verify the system is ready for enrolling) and re-activate the proper transmitter or transmitter loop input.

ZN ZT - RC IN: L
10 03 - 00 RF: 1 s

13. The summary screen for the zone will appear. Note that an "s" indicates that a serial number has, in fact, been enrolled. The cursor will be flashing above the loop number. Press [*] to accept the zone information.

Note: If you entered "0" in step 10 previously, you will not get an indication that the serial number has been enrolled.

If you want to delete the serial number, enter "0" and press [*]. The system will then prompt, "Delete S/N?" Press the "1" (Yes) key to complete the delete sequence. This process deletes the serial number only, **not** the loop number. The assumption is that the proper loop number was programmed, but the wrong serial or loop number was enrolled. To change the loop number, you must go back through zone programming for that zone and manually enter the loop number over the existing one.

Program Alpha?
0 = NO 1 = YES 0

14. If you want to program alpha descriptors now, enter "1" (Yes). See the *ALPHA DESCRIPTOR PROGRAMMING* section for more information. If not, enter "0" (No).

Enter Zn Num.
(00 = QUIT) 11

This will bring you back to the "Enter Zn Num." prompt for the next zone. When all zones have been programmed, enter "00" to quit.

If you plan to enroll serial numbers in the sequential enrollment mode, enter "00" to quit, then go to *Section 13. SEQUENTIAL MODE* section later in this manual to enroll the serial numbers.

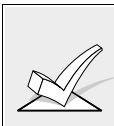

When you have finished programming all zones (including all serial numbers), test each zone using the system's TEST mode. Do not use the Transmitter ID Sniffer mode for this, as it will only check for transmission of one zone on a particular transmitter, and NOT the zones assigned to each additional loop.

To Either Temporarily Or Permanently Remove A Zone From The System (5800 System).

1. Enter the programming mode:
Key **Installer Code + 8 + 0** and press [*][5][6].
2. Enter the zone number and press [*]. A summary display will appear.
3. Press [*] again.

20 Zone Type
Not Used 00

4. The "**Zone Type**" prompt will appear. Enter [0][0]. This sets the zone type to "Not Used". Press [*] to continue.

20 Delete Zone?
1 = Yes 0 = No

5. The next prompt will ask whether you want to delete the zone.

"Yes" will permanently remove the zone from the system, while a "No" will disable it but retain all data except the original zone type. You can then go back to this zone later and put back an active zone type to re-enable it.

A serial number that has been entered for a 5800 system will not be deleted if the zone is temporarily disabled by answering "No" to the prompt above.

If only the physical transmitter is to be removed or changed (i.e., its serial number deleted, as when replacing a unit that has a non-removable battery), it can be done in *56 Mode, as indicated next.

Deleting a Transmitter Serial Number From a Zone in *56 Mode (5800 System)

The abbreviated procedure below can be used to delete a serial number from a zone, using the *56 Mode.

1. In the programming mode, press [*][5][6] to enter Zone Programming mode.
2. Then enter the zone number, and press [*] repeatedly until the cursor is under the RF Input Loop (L) position. This is the specific input (loop) or button on the transmitter that has been entered for that zone.
3. Enter a [0] at this point, then press [*].
4. A prompt "**Delete S/N?**" will appear.
Enter "Yes" to delete the existing serial number from the system.
Note that the other programmed values for that zone will not be deleted. This will allow you to re-instate a new transmitter in its place.
5. A display for the next zone number will appear. To exit, enter "00".
6. Press *99 to exit the programming mode.

Check-Out Procedure for Wireless Zones

Transmitter ID Sniffer Mode (5700/5800 RF Systems)

When all transmitters have been installed, use the Transmitter Sniffer Mode to test that they have all been properly programmed.

1. Enter **Installer Code + # + 3**. The keypad will display all zone numbers of wireless units programmed into the system.
2. Fault each wireless zone, causing each device to transmit. As the system receives a signal from each of the transmitters, the zone number of that transmitter will **disappear** from the display.



If a 5700 transmitter is not dipswitched correctly, or if a 5800 transmitter is not enrolled, its zone number will not turn off.

3. To exit the Transmitter Sniffer mode, enter the Installer Code + (OFF).

(Continued)

Go/No Go Test
(5700/5800
RF Systems)

Before mounting transmitters permanently, conduct Go/No Go tests to verify adequate signal strength and reorient or relocate transmitters if necessary.

During this mode, wireless receiver gain is reduced by 50%. Testing in this mode assists in determining good mounting locations for the transmitters and verifies that the RF transmission has sufficient signal amplitude margin for the installed system.

1. Enter the **Installer Code + # + 4**
2. Once transmitters are placed in their desired locations and the approximate length of wire to be run to sensors is connected to the transmitter's screw terminals, fault each transmitter. *Do not conduct this test with your hand wrapped around the transmitter as this will cause inaccurate results.*
 - The keypad will beep three times to indicate signal reception.
 - If the keypad does not beep, re-orient or move the transmitter to another location. Usually a few inches in either direction is all that is required.
3. Mount the transmitter according to the instructions provided with the transmitter.
4. Exit the GO/NO GO test mode by entering Installer Code + (OFF).

Section 6. RELAY OUTPUT DEVICES

Relay Device Basics

Relays are programmable switches that can be used to perform many different functions. They can be used to turn lights on and off, control sounders, or for status indications. In this system, each relay must be programmed as to how to act (ACTION), when to activate (START), and when to deactivate (STOP). Each of these is described below, and in the programming procedure for *80 and *81 interactive modes that are provided at the end of this section.

The control supports a total of 4 output relays.



The 4204 Relay modules provide Form C (normally open and normally closed) contacts.

In *80 and *81 interactive modes, a series of keypad prompts will request entries for programming of the Relay outputs used in the system. Refer also to "OUTPUT RELAY DEVICE WORKSHEET FOR *80 AND *81 INTERACTIVE MODES" in the blank programming form provided in the separate **Programming Guide** manual.

4204 Relay Modules

4204 Setup

The 4204 unit can be mounted either remotely or in the control panel. The following steps should be taken to properly set up the 4204:

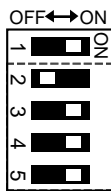

1. **Connect the 4204 to the control's remote keypad terminals (4–7)**, using the connector supplied with the 4204. Use standard 4-conductor twisted cable for long wiring runs.
2. **Set the 4204's DIP switch for a device address of "1"** (switch 2 "OFF" and switches 3, 4, and 5 "ON"). Switch 1 determines the unit's cover tamper response ("ON" = disabled, "OFF" = enabled).
3. **Connect the desired field wiring to the unit's relay contact terminals.** See Figure 9.

Supervision

4204 modules are supervised against removal. **CHECK** and zone **09** will be displayed if a module is disconnected from the control's keypad terminals (4, 5, 6, & 7).

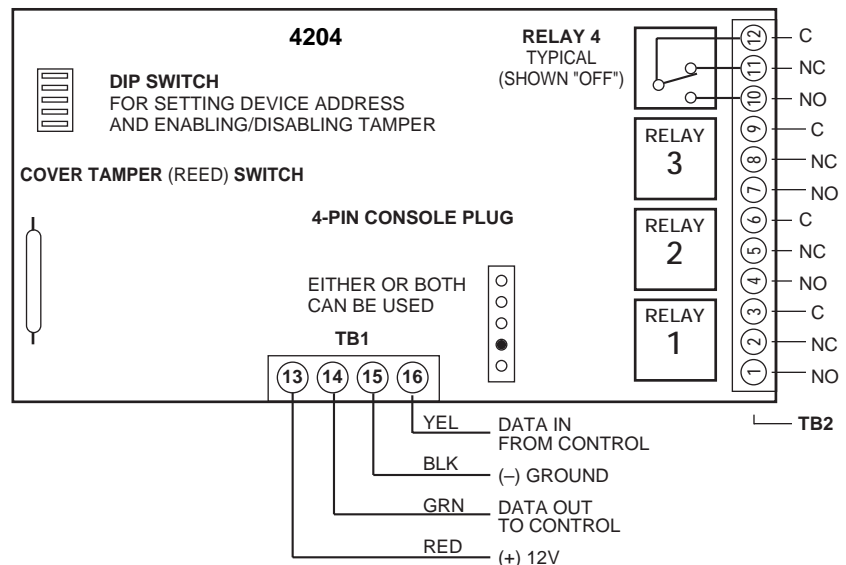

Figure 9. 4204 Connections to Control

Programming Options Defined

The following will help you understand the programming of OUTPUT RELAYS when using *80 and *81 modes. The options used to start and stop these relays are described below, followed by the actual screen prompts and available entries.

The letter(s) in parentheses after each function described below, such as (A) after ACTION, are those that appear in the various summary displays of programmed data during programming.

ACTION (A) The "ACTION" of the relay is how the relay will respond when it is activated by the "START" programming. You may want the relay to activate momentarily, to pulse on and off continuously, or to remain activated until some other event occurs to stop it. There are four different choices of actions:

- ACTIVATE for 2 SECONDS and then reset.
- ACTIVATE and REMAIN ACTIVATED until stopped by some other event.
- PULSE ON and OFF until stopped by some other event.
- NOT USED when the relay is not used.

START (STT) The "START" programming determines when and under what conditions the relay will be activated. The following START options are available:

A) 1. EVENT (EV) is the condition (Alarm, Fault, Trouble) that must occur to a zone or group of zones (zone list) in order to activate the relay. These conditions apply *only* when a zone list is used. The different choices for "EVENT" are listed below and in the "Programming Output Relays" section that follows.

- **ALARM** Relay action begins upon any alarm in an assigned zone in the zone list.
- **FAULT** Relay action begins upon any opening or short in an assigned zone in the zone list.
- **TROUBLE** Relay action begins upon any trouble condition in an assigned zone in the zone list.
- **NOT USED** Relay action is not dependent upon one of the above events.

2. ZONE LIST (ZL) is a group of zones to which the "EVENT" applies in order to activate a particular relay. Note that there are a total of 3 zone lists that can be programmed in field *81 mode; when the selected EVENT (Alarm, Fault or Trouble) occurs in **any** zone in the selected "Start" ZONE LIST (1, 2, or 3), activation of the selected relay will START.

B) 1. ZONE TYPE/SYSTEM OPERATION (ZT). If a System Operation, such as "DISARMING" or "ANY FIRE ALARM," is to activate the relay, the appropriate choice would also be entered under the "ZONE TYPE" option. "ZONE TYPE" is used independently of the "EVENT/ZONE LIST" combination.

If a specific "ZONE TYPE" is chosen, any zone of that response type going into alarm, trouble, or fault will cause the relay to activate as selected in "ACTION." If the same "ZONE TYPE" is also chosen for the STOP programming, any zone of that type that *restores* will de-activate the relay.

If a "SYSTEM OPERATION" is chosen (e.g., End of Exit Time), that operation will cause the relay to activate as selected in "ACTION." The different choices for "ZONE TYPE" and "SYSTEM OPERATION" are listed in "Programming Output Relays" later in this section, and in the Programming Form.

STOP (STP): The "STOP" programming determines when and under what conditions the relay will be de-activated. The following options are available:

- A) 1. **RESTORE ZONE LIST (ZL).** If a "ZONE LIST" is used as the "Stop" event, the relay will de-activate when **all** the zones in that list restore from a previous fault, trouble, or alarm condition. This will occur regardless of what is programmed to "START" the relay; therefore, a "RESTORE ZONE LIST" would normally only be used when a "ZONE LIST" is used to start the relay.
- B) 1. **ZONE TYPE/SYSTEM OPERATION (ZT).** Instead of using a "RESTORE ZONE LIST", a specific zone (response) type or system operation action can be selected to de-activate the relay.

If a specific "ZONE TYPE" is chosen, any zone of that response type that restores from a previous alarm, trouble, or fault condition will cause the relay to de-activate.

If a "SYSTEM OPERATION" is chosen, that operation will cause the relay to de-activate. The different choices for "ZONE TYPE" and "SYSTEM OPERATION" are listed in "Programming Relays" later in this section, and in the Programming Form.

	<p>If relay outputs are used, two keypad entries available to the user are included among the system operation choices (34 and 35) that may be programmed. They can manually activate or de-activate the relay(s) for starting or stopping some action, such as turning lights on or off, etc.</p> <p>These entries are: Security Code + [#] + [7] and Security Code + [#] + [8]</p> <p>Note: Whichever entry is used to start/stop the action cannot also be used to stop/start it. The opposite action must either be performed by the other keypad entry or by some other event or operation offered in the programming section.</p>
---	--

	<p>If a relay is energized before a 4-wire smoke detector is reset, the relay will be stopped by the interruption of Aux. Power that resets the smoke detector. If this is not desired, the power to the relay unit should be supplied from another 12V power source (e.g., the same source that is powering external equipment through the relay contacts).</p>
---	--

Programming Output Relays

1. With at least one 2-line Alpha keypad (5137AD or 6139) connected to the keypad terminals on the control, power up the system temporarily. If you had previously connected the AC transformer to the control panel, you need only plug in the transformer (to 120VAC outlet) to power up the system.
2. Enter the programming mode by keying the following on the Alpha keypad: **INSTALLER code (4 1 1 1) + 8 + 0.**

	<p>Field *25 OUTPUT MODULE must have been programmed for a 4204 module (enter "3").</p>
---	---

- 3 **Press *80.** Note that this is an interactive menu programming mode. It is used to program all output relays used in the system (4204 Relay modules). Refer to the Programming Form worksheet in the separate PROGRAMMING GUIDE for *80 Interactive Mode.

Output Relay Displays

Enter Relay No. (00 = Quit) 01
--

Upon pressing *80, this screen will appear. Enter the Relay Number 01, 02, 03, or 04 for a 4204 (or 00 to end these entries). Press the [*] key to continue.

The [*] key is used to accept an entry and advance to the next prompt. The [#] key is used to revert back to the last question to check or change an entry. Press [*] to go forward again.

02 A EV ZL ZT STT 0 0 0 00
--

This screen displays a summary of the current Relay START programming (for this example, relay 02 has been selected). Press the [*] key to continue.

02 A EV ZL ZT STP - - 0 00
--

This screen displays a summary of the current Relay STOP programming. Press the [*] key to continue.

02 Relay Action No Response 0

Enter the desired relay action as listed below. Press the [*] key to continue.
 0 = No response 2 = Close and Stay Closed
 1 = Close for 2 seconds 3 = Continuous Pulse on & off (1 sec ON, 1 sec OFF)

02 Start Event Not Used 0

Enter the event to START the relay:
 0 = Not used; 2 = Fault; 1 = Alarm; 3 = Trouble
 A zone list must be used in conjunction with an event. If a zone type/system operation is to be used instead of an event, enter 0. Press the [*] key to continue.

02 Start: Zn List No List 0
--

If a zone list will be used to START the relay action, enter the zone list number (to be programmed in field *81): 1, 2, or 3. If not used, enter 0. Press the [*] key to continue.

02 Start: Zn Typ Not Used 00

If a zone type or system operation will be used to START the relay action, enter the appropriate two-digit code (see table that follows). If not, enter 00. Press the [*] key to continue.

CHOICES FOR ZONE TYPES		
00 = Not Used	05 = Trouble Day/Alarm Night	08 = 24 Hr Aux
01 = Entry/Exit	06 = 24 Hr Silent	09 = Fire
03 = Perimeter	07 = 24 Hr Audible	10 = Interior w/Delay
04 = Interior Follower		
CHOICES FOR SYSTEM OPERATION		
20 = Arming-Stay	33 = Any Burglary Alarm	39 = Any Fire Alarm
21 = Arming-Away	34 = Code + # + 7 Key Entry	40 = Bypassing
22 = Disarming (Code + OFF)	35 = Code + # + 8 Key Entry	41 = AC Power Failure
31 = End of Exit Time	36 = At Bell Timeout**	42 = System Batt. Low
32 = Start of Entry Time	38 = Chime	58 = Duress
**Or at Disarming, whichever occurs earlier.		

02 Stop: Zn List No List 0

If a zone list will be used to STOP, or restore, the relay action, enter the zone list (ZL) number 1, 2, or 3 (to be programmed in *81 mode). If not used, enter 0. Press the [*] key to continue.

02 Stop: Zn Typ Not Used 00
--

If a zone type or system operation will be used to STOP the relay action, enter the appropriate two digit code (see the "ZT" choices listed above). If not, enter 00. Press the [*] key to continue.

02 A EV ZL ZT STT 0 0 0 00
--

This screen again displays a summary of the current relay START programming. Press the [*] key to continue.

02 A EV ZL ZT STP - - 0 00
--

This screen again displays a summary of the current relay STOP programming. Press the [*] key to continue.

The display then returns again to the first screen so that the next relay number to be programmed can be entered, or enter [0][0] to end relay programming.



Previously entered data can be reviewed by pressing [#] [8] [0]. After the relay number is chosen, press [*] to go to the next screens. This is a review mode only, and data cannot be changed.

Example of Output Relay Programming

A lamp is to be turned on when any one of 3 specific zones are faulted or when any 24-hour auxiliary zone is disturbed. We want to turn off the lamp manually without affecting the arming status of the system.

In field *80 we choose Output Relay 01 and program the Action (A) to be "2" (Close and stay closed). The Event we are looking for to *start* the relay action is a fault, so we will program "2" in (EV). We will use Zone List 1 for the 3 specific zones, so will program "1" in (ZL), (and will program these 3 zones in field *81's Zone List 1).

The second condition for turning on the indicator is triggering a 24 hour aux. zone (Zone Type 08), so we will program (ZT) as "08".

To *stop* relay action and turn off the indicator, we do not want to use a restore of any zone, so we will program a "0" for the "Restore of" Zone List (ZL). To choose a manual entry of User Code + [#] + [7] to turn it off, we will program (ZT) as "34".

If no other relay is to be programmed we go to field *81 and program the 3 specific zones in Zone List 1.

Press *81. (Zone Lists for Output Relays). This interactive mode is applicable only if you have programmed *80 mode.

Refer to the Programming Form worksheet for *81 Mode.

Zone List Displays ↓

Zone List No. (00 = Quit)	01
------------------------------	----

Upon keying *81, this screen will appear. Enter the Zone List Number 01, 02, or 03 to program (or 00 to end these entries). Press the [*] key to advance.

In the following displays, zone list 01 has been selected for programming.

01 Enter Zn Num. (00 = Quit)	00
---------------------------------	----

Enter each zone number to add to the zone list by first entering the zone number, then the [*] key (example, 01*, 02*, 03*). After all zones desired are entered, press 00 to advance.

01 Del Zn List? 0 = No 1 = Yes	0
-----------------------------------	---

To delete the zone list, enter 1 (Yes). All zones in the zone list will be deleted automatically. and programming will return to the first screen.

To save the zone list, enter 0 (No) to advance.

01 Delete Zone? 0 = No 1 = Yes	0
-----------------------------------	---

To delete a zone or zones in a zone list enter 1 (Yes) to advance.

01 Zn to Delete? (00 = Quit)	00
---------------------------------	----

Enter each zone to be deleted from the list, followed by the [*] key. After all zones to be deleted are entered, enter 00 to return to the first screen so that another list can be programmed, if desired.

Notes:

- Any list may include any or all of the system's zone numbers.
- A zone list can be assigned to more than one output relay.
- *If you only want to review what has been programmed previously*, enter [#][8][1]. The review can be advanced by using the [*] key. When finished, enter [0][0] * to quit. No programmed values can be changed in this mode.

When programming in *80 and *81 interactive modes is completed, exit the programming mode by keying *99.

Section 7. 4285 PHONE MODULE

This section provides instructions for mounting the 4285 Phone module, wiring the Phone module and for programming the system for phone access via the Phone module.

Installing the Phone module

General Information

The 4285 Phone module is an add-on accessory for the VISTA-10SE that permits access to the security system via a Touch-tone phone (either on premises or by a call-in when away).

The Phone module can announce many of the same words that would normally be displayed on an Alpha keypad under the same system conditions.



When using the 4285 Phone module, addressable keypads must be used in the system, but set to the non-addressable mode (address 31), i.e., do not use a 4127 or 6127 keypad.

When properly connected, the 4285 Phone module will enable the user to do the following via a Touch-tone telephone:

- a. Receive synthesized voice messages over the phone regarding the status of the security system.
- b. Arm and disarm the security system and perform most other commands using the telephone keypad, with voice annunciation being provided over the phone as confirmation after a command is entered.

The phone used for phone access must have Touch-tone capability, though Touch-tone service is not necessary (if premises uses PULSE dialing, switchable phones must be set for Touch-tone temporarily before attempting phone access).

A **Phone Access User's Guide** for phone access to the security system is provided with the Phone module for the user of the system.



The Phone module is not Listed for UL installation use..

Mounting The 4285 Phone module

The Phone module may be mounted in the control cabinet if space is available or, if this is not possible, on the side of the cabinet or adjacent to it.

When mounting the Module outside the cabinet, use the screw holes at its rear which will permit it to be mounted horizontally or vertically (2-faced adhesive tape may be used, if preferred). Wires can be brought out from the side or back (a round breakout is also available on the back).

Affix the Phone module's connections label (supplied separately) to the inside of the Phone module's cover if the cover is used. If you have installed the module within the cabinet, affix the label to the inside of the control cabinet's door.

Phone Module Wiring

The 4285 is wired between the control panel and the premises handset(s). It listens for touch tones on the phone line and reports them to the control panel. During on-premises phone access, it powers the premises phones; during off-premises phone access, it seizes the line from the premises phones and any answering machines.

Note: The phone lines must be in service for the phone module to function, even when accessing the system from an on-premises phone.

1. Make 12V (+) and (-) and data in and data out connections from the Phone module to the control, using the connector cable supplied with the Phone module (see Figure 10).

Color Lead	Terminal On Control *
GREEN	DATA IN (terminal 6)
BLACK	AUX - (terminal 4)
RED	AUX + (terminal 5)
YELLOW	DATA OUT (terminal 7)

* These are the same connections as those used for remote keypads .

2. Insert the keyed connector at the other end of the connector cable into the mating header on the Phone module (see diagram on next page for location of the header).
3. Connect terminals 1 through 5 on the Phone module as shown in the Wiring Table and in the 4285 wiring diagram that follows.



Use an RJ31X jack with a direct-connect cord and make all connections exactly as shown. If the leads on the direct-connect cord are too short to reach their assigned terminals, splice additional wires to them, as required.

4285 WIRING TABLE

4285 Terminal	Connects to:
1: Phone In (Tip)	Terminal (17) on control.
2: Phone In (Ring)	Terminal (18) on control.
3: Phone Out (Tip)	BROWN lead from direct-connect cord.
4: Phone Out (Ring)	GRAY lead from direct-connect cord.
5: Ground	Earth ground terminal (21) on control.
6: <i>Not Used</i>	
7: <i>Not Used</i>	



If no touch tones are produced following access to the security system **from on-premises** (this problem may arise in rare cases), it may be necessary to reverse the wires connected to terminals 3 and 4 on the Phone module **and** the wires connected to terminals (17) & (18) on the control. The wiring diagram shows the wiring connections that will provide proper operation in most cases.

Caller ID Units

If the telephone system on the premises includes a Caller ID unit, connect the ID unit directly to the "Handset" terminals (17 & 18) on the control, as shown in 4285 Phone module Wiring Connections diagram that follows.

4285 WIRING NOTES:

1. Wire the 4285 Phone module exactly as shown, using a direct-connect cord and RJ31X jack.
2. If Touch-tones are not heard when pressing keys following phone access to the security system *via an on-premises phone*, try reversing the pair of wires connected to terminals 3 & 4 on the 4285, **and** the pair of wires connected to terminals 17 & 18 on the control.
3. If an error signal (fast busy signal) is heard when trying to access the system via the phone, check for correct line seizure wiring, as described in note 4.
4. Connection to the incoming Telco line via a RJ31X jack and direct-connect cord, as shown in this diagram, is essential, even if the system is not connected to a central station. **The 4285 will not function if this is not done.**
The house phone lines (gray and brown wires) must be wired to the Phone module terminals, not to the control terminals. Otherwise, an error signal (fast busy signal) will occur when trying to access the system from an on-premises phone.
5. If the telephone system on the premises includes a Caller ID unit, connect the ID unit **directly** to the "Handset" terminals (17 & 18) on the control, as shown.

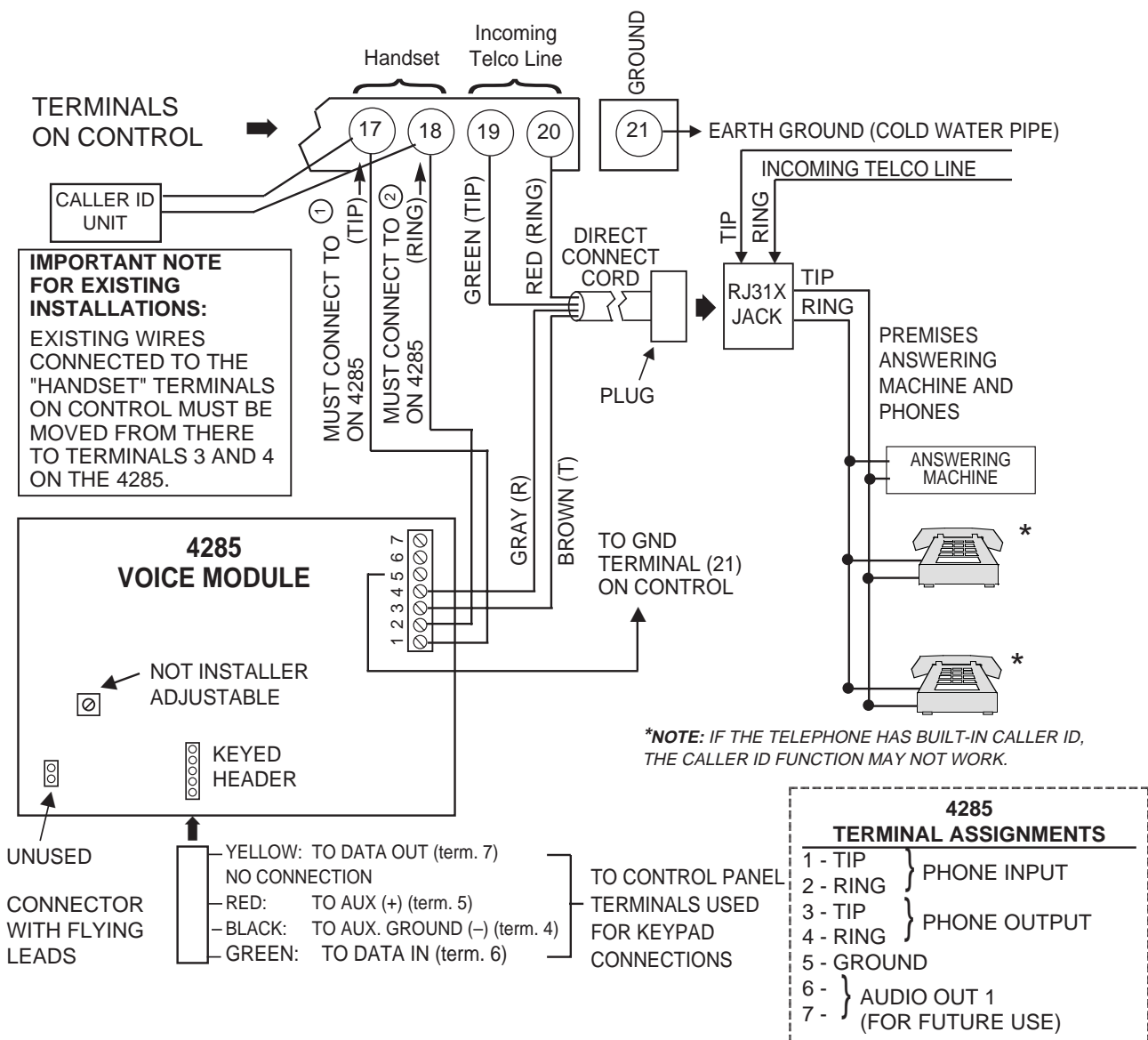

Figure 10. 4285 Phone module Wiring Connections

Programming The Control For Phone Access

1. With at least one addressable keypad (but set to the non-addressable mode, address 31) connected to the keypad terminals on the control, power up the system temporarily. If you had previously connected the AC transformer to the control panel, you need only plug in the transformer (to 120VAC outlet) to power up the system.
2. Enter the programming mode by keying the following on the keypad:
INSTALLER code (4 1 1 1) + 8 + 0.
3. **Press *26. VOICE (PHONE) MODULE ACCESS CODE.**
If using a 4285 Phone module, enter the 2-digit phone access code as follows: For first digit, enter 1–9; for second digit, enter # +11 for "*", or # +12 for "#". Example: if desired access code is 7* , 7 is the first entry, and # + 11 (for *) is the second entry.
Enter "00" if not using a Phone module (this is the default).
NOTE: a "0" in either digit will disable the phone module.
4. **Press *95. RING DETECTION COUNT .**
Refer to the chart below and program this field accordingly.

Voice Module	Answering Machine	Downloading	Field *95 Programming
Yes	No	No	Set for value other than "0" (1–14). This will enable the control panel to answer the phone call. Otherwise, it will not be possible to access the Phone module.
Yes	Yes	No	Set for a value higher than the number of rings for which the answering machine is set. Example: if the machine is set for 4 rings, use a value of 5 or higher. This is recommended so that the Phone module can still be accessed if the answering machine is turned off and does not answer the phone call.
Yes	No	Yes	Set for value other than "0" (1–14).
Yes	Yes	Yes	Enter "15" to bypass the answering machine. See Important Note below.

Important Note: If "15" is entered in field *95 to bypass an answering machine, and a 4285 Phone Module is included in the installation, you should note the following:

When calling in from an off-premises phone (to receive a status report or execute a command), the user should make the initial call, allow 1 to 3 rings only, and hang up. Then call in again – the Phone Module will now seize the line, and 2 long tones will be heard, followed by the usual voice prompt for the 2-digit phone access code. If this procedure is not followed, Phone Module operation will not be possible.

5. Zone descriptors should also be programmed, regardless of the type of keypads in use. If this is not done, the Phone module will not announce a description of the zone(s) in alarm, trouble, etc. (the Phone module will announce zone numbers only).
You can enter zone descriptors now using interactive mode *82, or later. See the *ALPHA DESCRIPTOR PROGRAMMING* section for a detailed procedure.
6. Exit the programming mode by entering *99.

Perform a preliminary check of the 4285 Phone module, as indicated next.

Checking the Operation of the 4285 Phone module

To Check Phone module Operation From an On-Premises Phone

1. Pick up phone and enter the programmed 2-digit phone code (entered in field ★26, VOICE (PHONE) MODULE ACCESS CODE). Annunciation of a system status report should automatically start. See the User's Guide accompanying the Phone module for detailed information regarding the nature of the status report, if necessary.
2. During any pause in the status report, or immediately following it, key the following via the keypad on the phone:
INSTALLER Code (4111), then press key **1** (OFF).
3. A "beep" should be heard on the phone and from a wired keypad, and the words **DISARMED...READY TO ARM** or **DISARMED...NOT READY TO ARM*** should be heard, indicating that the command was entered successfully.
* DISARMED...NOT READY TO ARM would indicate an open zone.
4. Hang up the phone.

To Check Phone module Operation From an Off-Premises Phone:

1. Have someone dial the premises phone number, using a Touch-tone phone.
 - If the phone system does not include an answering machine, 2 long tones will be heard in the caller's phone, followed by a voice prompt "**HELLO, ENTER PHONE CODE NOW**". The caller should then enter the programmed 2-digit phone code (entered in field ★26, VOICE (PHONE) MODULE ACCESS CODE).
 - If the premises phone system includes an answering machine, the 2-digit phone code should be entered **during a pause** at the beginning of, or during, the outgoing answering machine message.
2. When the 2-digit phone code is entered, the caller will hear a voice prompt asking for entry of the 4-digit system code ("**ENTER SYSTEM CODE NOW**").
3. The caller should then enter the INSTALLER code (4111). As a safety feature, there is a 3-try limit in which to enter each code (phone code and system code), after which time the call-in will be aborted. Also, if no keys are pressed for a period of 20 seconds, the call-in will be aborted.
4. Annunciation of a system status report will start if both codes were entered correctly.
5. During any pause in the status report, or immediately following it, the caller should key the following via the keypad on the phone:
INSTALLER Code (4111), then **1** (OFF).
6. A "beep" should be heard (and from a wired keypad on the premises), and the words **DISARMED...READY TO ARM** or **DISARMED...NOT READY TO ARM*** should be heard on the caller's phone, indicating that the command was entered successfully.
* DISARMED...NOT READY TO ARM would indicate an open zone.
7. At this point, the caller can hang up the phone.
8. Verify with the caller that there was successful access to the system and that the appropriate annunciations were heard over the phone.

Section 8. EXTERNAL SOUNDERS

This section provides a list of compatible sounders, connection information for an external siren and programming procedures for those options that affect the operation of external sounders.

Compatible Sounders

Ademco AB-12M 10" Motorized Bell & Box	Motor bell & box. UL Grade A. 100mA current draw.
Ademco 1011BE12M 10" Motorized Bell & Box	Motor bell & box. UL Listed. 100mA current draw.
Ademco 702 Outdoor Siren	Self-contained 6–12 volt siren (driver built-in) and weatherproof for outdoor use. Can be wired for either a steady or warble sound. 117dB @ 10 feet. 1500mA current draw.
Ademco 719 2-Channel Siren	Self-contained 6–12-volt siren (driver built in). Steady or warble sound. 109dB @ 10 feet. 550mA current draw.
Ademco 747 Indoor Siren	Self-contained 6–15 volt siren (driver built-in) for indoor wall mount. 747F available for flush mounting. 105dB @ 10 feet. 400mA current draw.
Ademco 747UL Indoor Siren	Self-contained 6–15 volt siren (driver built-in) for indoor wall mount. UL Listed. 85dB @ 10 feet. 320mA current draw.
Ademco 744 Siren Driver	6 jumper-selected sound outputs. Rated at 119dB with use of an 8-ohm 30 watt speaker. 1.3 amps current draw.
Ademco 745X3* Voice Siren Driver	12 volt voice siren driver with English, Spanish and French voice messages. Separate messages for Fire and Burglary. Use with 8-ohm speaker. UL Listed. 1100mA current draw.
Ademco 705–820, 5-inch Round Speaker	20-watt, 8-ohm indoor or outdoor speaker. Requires a driver.
Ademco 713 Speaker	40-watt, 8-ohm, indoor/outdoor speaker. Requires a driver.
System Sensor PA400B (beige)/PA400R (red) Indoor Piezo Sounder	Indoor piezo sounder (red or beige), rated at 90 dB @ 10 feet.

* Requires special power wiring, using additional components.

UL	<ul style="list-style-type: none"> • Use only UL Listed sounding devices for UL installations. • The total current drawn from the alarm output and the auxiliary power output, <i>combined</i>, cannot exceed 600mA. In addition, the sounding device must be a UL Listed audible signal appliance rated to operate in a 10.2-13.8 VDC voltage range, and must be mounted indoors. Example: Wheelock Signals Inc. siren model 34T-12 (provides 85dB[A] for NFPA 74 & Standard 985).
-----------	---

Non-UL Installations

The total current drawn from the alarm output terminals cannot exceed 2 amps. The back-up battery must be installed since this current is supplied by that battery.

	Going beyond the limits indicated (2 amps) will overload the power supply, or may cause the electronic circuit protecting the sounder output to trip.
---	---

This control complies with NFPA requirements for temporal pulse sounding of fire notification appliances.

Temporal pulse sounding for a fire alarm consists of the following:

3 pulses – pause – 3 pulses – pause – 3 pulses. . . repeated.

Sounder Connections

The VISTA-10SE provides a 12 VDC output which can power external alarm sounders (bells or sirens, see compatible sounders listed previously). This output will activate a sounder when an alarm occurs.

Make connections to alarm output terminals **3 (+)** and **4 (-)**. See Figure 11.

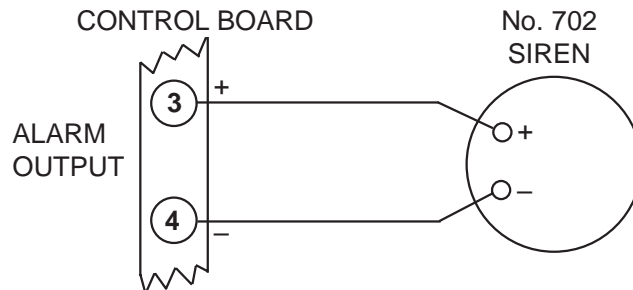

Figure 11. Typical Sounder Wiring

Programming for External Sounders

1. With at least one 2-line Alpha keypad (5137AD or 6139) connected to the keypad terminals on the control, power up the system temporarily. If you had previously connected the AC transformer to the control panel, you need only plug in the transformer (to 120VAC outlet) to power up the system.
2. Enter the programming mode by keying the following on the Alpha keypad:
INSTALLER code (4 1 1 1) + 8 + 0.
3. **Press *28. Single Alarm Sounding per Zone/Armed Period.**
Enter "1" for yes, "0" for no (default).
4. **Press *29. Fire Sounder Timeout.**
Enter "1" for no timeout, "0" for timeout (default).
5. **Press *30. Alarm Bell Timeout.**
Enter 0 for no timeout, 1 for 4 min (default), 2 for 8 min, 3 for 12 min, 4 for 16 min.
6. **Press *51. Confirmation of Arming Ding.**
Enter "0" for no (default), "1" for yes, "2" for yes, but with RF arming only.
7. Exit the programming mode by entering *99.

Testing the Sounder

After installation of the sounder is completed, the Security System should be carefully tested, as follows.

1. Connect the battery wires from the control board to the battery, observing correct polarity.
2. Enter the **INSTALLER code (4 1 1 1)** and press the **TEST** key on the wired keypad.
The external sounder should sound for 1 second if the sounder is good and proper connections have been made. Note that if the backup battery is discharged, the sounder will not turn on.
3. To turn off the test mode, enter the **INSTALLER code (4 1 1 1)** and press the **OFF** key.

Section 9. LONG RANGE RADIO

General Information

Check availability of Model 7720PLUS or 7820 long range radio.

If output to long range radio is selected, all messages that are programmed to go to the primary telephone line receiver will also be sent to the 7720PLUS or 7820 long range radio. These messages will be in Contact ID format (not affected by entry in field *46).

The data line is supervised, as well as certain functions in the radio. If communication is lost or a trouble develops, a message will be attempted to be sent via both radio and telephone to the central station.

For complete information, see the manual that accompanies the radio.

Connection

Connect the data in/data out terminals and voltage input terminals of the Long Range Radio to the control's keypad connection points, terminals 4, 5, 6, and 7 as shown below.

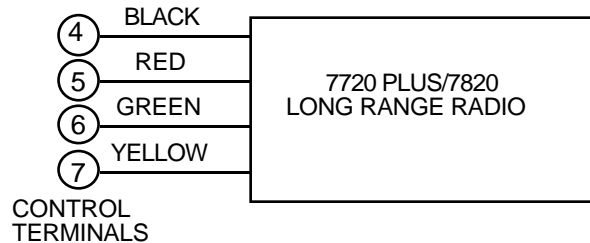

Figure 12. Long Range Radio Connections



Programming for Long Range Radio

1. With at least one keypad connected to the keypad terminals on the control, power up the system temporarily. If you had previously connected the AC transformer to the control panel, you need only plug in the transformer (to 120VAC outlet) to power up the system.
2. Enter the programming mode by keying the following on the Alpha keypad:
INSTALLER code (4 1 1 1) + 8 + 0.
3. **Press *27 OUTPUT TO LONG RANGE RADIO**
Enter **1** when using a Long Range Radio; enter **0** if not (default is 0).
If yes is selected, any dialer report programmed to report to the PRIMARY phone number (in field *47) will be sent, as well, via long range radio. All dialer and long range radio reports will be in Contact ID format (regardless of the selection made in field *46).
Full Trouble and Restore messages are sent.
5. Program the long range radio for device address "3" on the keypad lines.
6. Exit the programming mode by keying ***99**.

Section 10. AUDIO ALARM VERIFICATION (AAV) UNIT

General Information

An Audio Alarm Verification (AAV) module, such as the Eagle 1241, is an add-on accessory that permits voice dialog between an operator at a central station and a person at the alarm installation, for the purpose of alarm verification.

	Alarm reports must be programmed for the primary phone number to enable this feature.
	AAV should not be used when Paging or Alarm Reports are being sent to a Secondary number. If this is done, the call to the Secondary number by the communicator after the alarm report will prevent the AAV from taking control of the telephone line, and the AAV "Listen in" session cannot take place.
UL	The AAV option cannot be used in UL installations.

After all messages have been sent during a reporting session to the primary phone number, the control will trigger the AAV if at least one of the messages was an alarm report. If Contact ID format is selected for the primary phone number, the control will send a "listen-in to follow" message (event code 606), which signals the 685 receiver at the central station to hold the phone connection for 1 minute.

Once the digital message is "kissed off", the control will give up the phone line to the AAV module, without breaking connection with the central station. At this time, all sirens and all continuous keypad sounds will be shut off.

	You must connect a 4204 relay module when using an AAV unit. Do not use relay output number 1 for any other usage.
---	--

Wiring Connections

The method used to trigger AAV is via the use of a 4204 relay module, as shown in the AAV connection diagrams that follow (one diagram for connections when a 4285 Phone module is used, the other when the 4285 is not used).

Programming

1. With at least one 2-line Alpha keypad (5137AD or 6139) connected, power up the system. If you had previously connected the AC transformer to the control panel, you need only plug in the transformer (to 120VAC outlet) to power up the system.
2. Enter the programming mode by keying the following on the Alpha keypad:
Installer code (4 1 1 1) + 8 + 0.
3. **Press *91. OPTION SELECTION.** Enter "4" for AAV monitoring. Enter "0" for none. **For UL installations, enter "0" (no AAV).**
4. **Relay programming in field *80:** Do not program anything for Relay #1.
5. Exit the programming mode by keying *99.

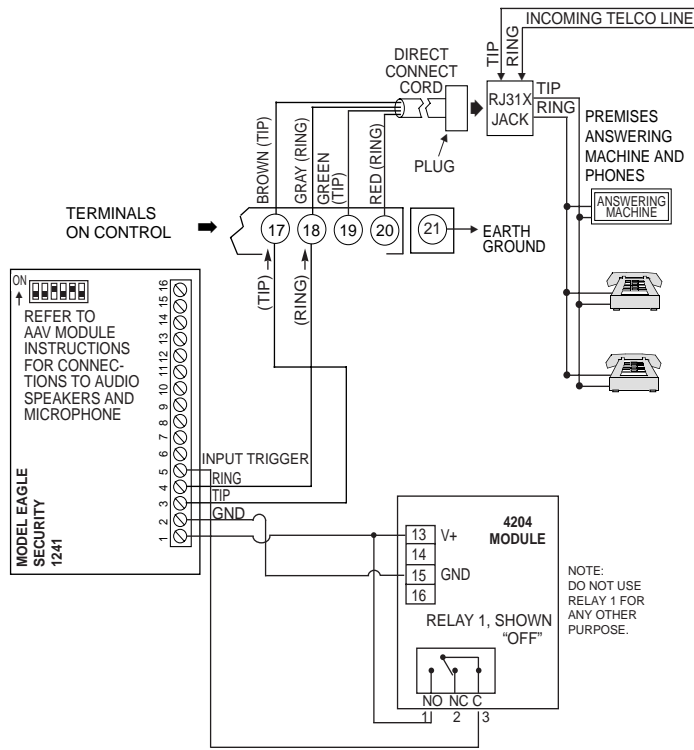

Figure 13. Connection Of AAV Unit When Not Using A 4285 Phone module

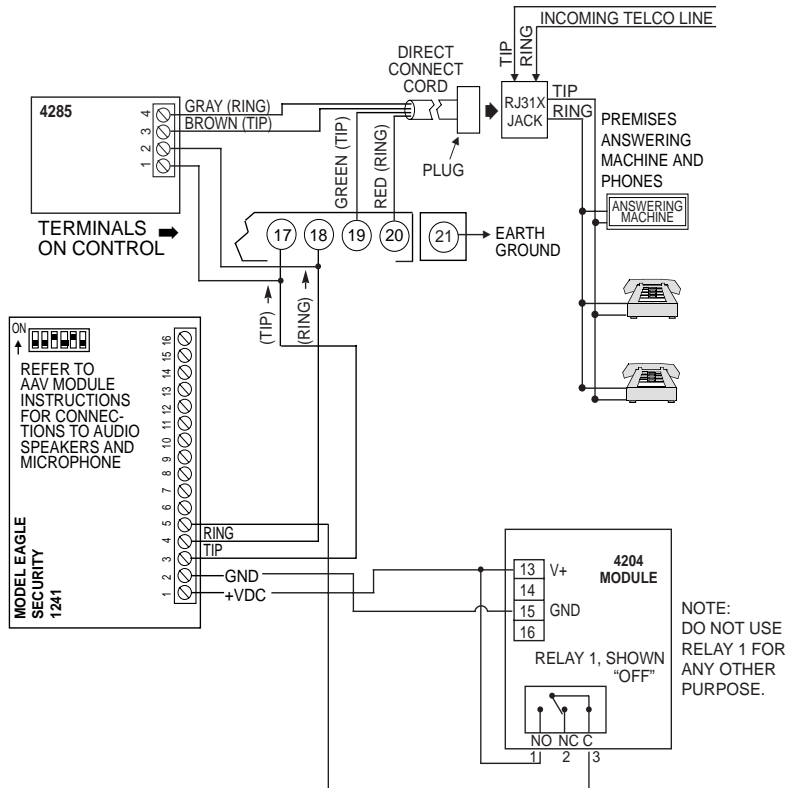

Figure 14. Connection Of AAV Unit When Also Using A 4285 Phone module

Section 11. FINAL POWER UP

In previous sections, you made temporary power connections for the purpose of programming and testing. This section provides information about final power-up procedures and battery size calculations.

Earth Ground Connections

The designated earth ground terminal (21) must be terminated in a good earth ground for the lightning transient protective devices in this product to be effective. See the *INSTALLING THE CONTROL* section earlier in this manual.

AC Power-Up

1. Plug the 1321/TF2 transformer into a 24-hour, uninterrupted 120VAC outlet.
2. Following power-up, **AC, dl** (disabled), or **System Busy** (Alpha keypads) or **NOT READY** (fixed-word keypads) will be displayed. Also the green "READY" LED* on the keypad(s) should light.

* Some keypads are equipped with a "POWER" LED in place of a "READY" LED.

After approximately 1 minute, the initial displays will revert to **DISARMED...READY TO ARM** for Alpha keypads, or **READY** for Fixed-word keypads (if there are no faulted zones). This 1-minute delay allows PIRs, etc. to stabilize.

To bypass this delay, press: [#] + [0].

Note: If you do not get the "Ready" displays described above, refer to "Trouble Conditions" in the *SYSTEM OPERATION* section, and also to the *TROUBLESHOOTING GUIDE* section.

Connecting The Back-Up Battery

In the event of an AC power loss, the Control panel is supported by a back-up, rechargeable gel cell battery. The minimum battery size recommended is the No. 467 (12V, 4AH) battery. See "Calculating Battery Size Needed" below. The battery is installed in the control cabinet.

The standby battery connection is automatically checked every 3 minutes (CSFM requirement). In addition, entry into the test mode will cause a battery test to be initiated. If there is no battery or a low battery, a low battery message is displayed and, if so programmed, will be reported to the central station.

Calculating the Battery Size Needed

Determine the total device current draw after filling in the AUXILIARY DEVICE CURRENT DRAW WORKSHEET on the next page. To this figure add the 100mA that is drawn by the control panel itself. Then, to determine the battery size needed, use the following formula:

Total Current Drawn* x Number of hours standby wanted = Battery Ampere/Hours.

* Convert mA figure to decimal Amps (see example).

Example:

If total auxiliary device current drawn is 450mA, add 100mA for the control panel, for a total of 550mA (0.55 amps); if 24-hour standby is wanted, the calculation will be:

$$0.55\text{mA} \times 24 \text{ hours} = 13.2 \text{ Ampere/Hour battery needed.}$$

In this example, two 7 Amp/Hr batteries (connected in parallel) must be used.

Making the Battery Connections

1. Use the battery standby formula (shown on previous page) to select the appropriate battery for the installation.

Remember, when calculating the battery size needed, you must add the 100mA drawn by the control itself to the total Auxiliary current draw in the worksheet below.

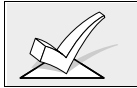

Do not connect the battery until all devices have been wired to the control.

2. Attach the Red and Black wires on the battery connector cable as follows:
 - a) Red to the positive (+) battery tab on the control board.*
 - b) Black to the negative (-) battery tab on the control board.*

*This not required if wires are already connected to the battery tabs on the control.
3. Attach the Red and Black wires at the other end of the battery connector cable to the battery, as follows:
 - a) Red to the positive (+) terminal on the battery.
 - b) Black to the negative (-) terminal on the battery.

AUXILIARY DEVICE CURRENT DRAW WORKSHEET

DEVICE	CURRENT	# UNITS	TOTAL CURRENT (device mA x # of units)
4127 Keypad	20mA		
4137AD Keypad	60mA		
5137AD/ADR Keypad	90mA		
6127 Keypad	20mA		
6128 Keypad	30mA		
6137 Keypad	85mA		
6138 Keypad	100mA		
6139/6139R Keypad	100mA		
4281/5881/5882 Type RF Receiver	35mA		
4204 Relay Unit	15/180mA‡		
4285 Phone module	160mA		
Long Range Radio	Depends on type of Radio used (see its instructions).		
*			
*			
*			
*			
TOTAL =			
(Current available from Aux. terminals = 500mA max.)**			

* If using hard-wire devices such as PIRs, refer to the specifications for that particular unit's current draw, and include on worksheet.

‡ Figures are for relays OFF/relays ON.

** In UL installations, maximum current draw from the Auxiliary Output and the Alarm Output **combined** must not exceed 600mA.

Section 12.

ALPHA DESCRIPTOR PROGRAMMING

This section provides instructions for programming Alpha descriptors. This is recommended for systems using Alpha keypads, and necessary if a 4285 Phone module is used. Alpha descriptors cannot be displayed on fixed-word keypads.

If using a 4285 Phone module, select from those words in the Alpha Vocabulary list (on a following page) shown in **boldface type**. *The Phone module will not provide annunciation of the other words.*

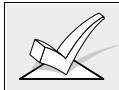

If a 4285 Phone module is added to an existing VISTA-10SE system, *the Alpha descriptors presently in the system should be re-programmed*, selecting from those words shown in **boldface type** in the Alpha Vocabulary list. The Phone module will not provide annunciation of any other words.

The ALPHA VOCABULARY LIST and CHARACTER CHART will be found on a following page.

Assigning Zone Descriptors

The Alpha Keypad used with the VISTA-10SE can have a user-friendly English language descriptor/location of all protection zones, keypad panics, and RF receiver supervision faults programmed into the system. Each descriptor can be composed of a combination of words (up to a maximum of 3) selected from a vocabulary of words stored in memory (see the list on a following page). In addition, up to 5 installer-defined words can be added to those already in memory. Thus, when an alarm or trouble occurs in a zone, an appropriate descriptor for that zone's location will be displayed at the keypad.

Note: Alpha Descriptor entry can be done locally at the Alpha Keypad or remotely using Downloading software. The Alpha keypad procedure is described below.

Entering Zone Descriptors (program menu mode *82)

The descriptor can be entered when the zone is being defined in field *56. Alternatively, zone descriptors can be entered in field *82.

There are two methods that can be used to enter Alpha descriptors.

The easiest method requires that you simply enter the 3-digit reference number for the desired word(s). The 3-digit number for each word is provided in the Alpha Vocabulary list (on a following page).

An alternate method allows you to pick the desired words by scrolling through the Alpha Vocabulary list.

Programming the Descriptors

1. With the system powered up, enter the programming mode by keying: **Installer code (4 1 1 1) + 8 + 0**. The following display will appear:

Installer Code
20

Program Alpha ?
0 = No, 1 = Yes 00

2. **Press *82.**

The "Program Alpha ?" prompt will appear.

Custom Words ?
0 = No, 1 = Yes 00

3. **Press "1" (Yes).**

The "Custom Words" prompt will appear.

4. **Press “0” (No).*** The system will then automatically display the default descriptor for zone 1.

* The procedure for adding custom words to the built-in vocabulary will be found later under “Adding Custom Words”.

If a descriptor was not entered previously for zone 1, the default descriptor for zone 1 will be displayed.

Note that no entries can be made. Entries can be made only when the display contains a flashing cursor, which signifies the “entry mode”.

5. To delete or change the default descriptor for zone 1, **press [*] plus the same zone number (01)**. This will clear that descriptor and gain access to the entry mode with flashing cursor, allowing changes to be made.

NOTE: If you do not wish to change the existing descriptor for zone 1, enter [*] plus the next zone number for which you wish to enter (or check) a descriptor. A summary display for that zone will appear. You must then press [*] plus the same zone number again to gain access to the entry mode (flashing cursor) for that zone.

6. **Press # plus 3-digit number** for the first word from the “ALPHA VOCABULARY LIST” on a following page. *Example:* The descriptor that we wish to enter for zone 1 is BACK DOOR. From the list, BACK = 013. Therefore, you would enter **# 0 1 3**.

Note: If you accidentally enter the wrong word, simply press # plus the correct 3-digit number for the word you want.

7. **Press “6” to accept the selected word and continue.**

Note: If this is the only word you are using for the descriptor, press “8” instead of “6” to save that word in memory, and then go to step 11.

8. **Enter the 3-digit number for the next word.** In our example, the word is DOOR, whose number is “057”.

Enter **# 0 5 7**. This display will appear:

Default Descriptor ↓
 ★ ZN 01 ZONE 01

Flashing Cursor (system is ready for entry of word).
 ↓

★ ZN 01 A

Flashing Cursor ↓

★ ZN 01 B ACK

★ ZN 01 BACK
 A

↑ Flashing Cursor if “6” is pressed (system is ready for next word).

★ ZN 01 BACK
 D OOR

↑ Flashing Cursor

```

★ ZN 01  BACK
DOOR  A

```

Flashing Cursor if "6" is pressed (system ready for next word).

```

★ ZN 01  BACK
DOOR

```

```

Program Alpha ?
0 = No, 1 = Yes 00

```

```

Alpha Pgm           82

```

9. Press "6" to accept the selected word.

Note: If these are the only words you are using for the descriptor, press "8" instead of "6" to save them in memory.

10. The two words in our example have now been entered. Note, however, that up to three words may be entered (provided the number of characters will fit on the screen). Press "8" to save all words in memory.

The "A" with the flashing cursor over it will disappear, indicating that the word(s) are stored in memory for that zone, as shown in the display at the left.

11. To enter a descriptor for the next zone, press [*] plus the desired zone number (e.g., *02. The summary display following step 4 previously will appear.

Now repeat steps 6 through 10 for the descriptor for the next zone.

12. To exit the Alpha descriptor mode, press "*00" at the summary display. This prompt will be displayed.

13. Press "0". This will be displayed.

14. Press *99 to exit the programming mode.

Alternate Method For Programming Zone Descriptors

When entering the Zone Descriptors using this method, the keypad keys perform the following functions:

- [3] Scrolls both alphabet and actual words in *ascending* alphabetical order.
- [1] Scrolls both alphabet and actual words in *descending* alphabetical order.
- [6] Selects between alphabet and actual word list; also used to save words.
- [8] Stores the zone description in memory.

1. Perform steps 1 through 5 of the previous method.
2. Note that the first letter of the alphabet appears after the zone number, and that the zone number is automatically included with the description. *If there already is a description for the zone, the description will appear (with no cursor, since this is a display mode). To enter or change a description, press [*] + Zone Number again. A flashing cursor will now appear.* Assume, for example, that the desired description for zone 1 is BACK DOOR.
3. **Select the first letter of the desired description** (note that "A" is already displayed). Press key [3] repeatedly to advance through the alphabet (e.g., to "B"), or key [1] to go backward. Then press [6] to display the first available word beginning with the desired letter (e.g., BABY). Next, press [3] repeatedly to move forward, or [1] to move backward, until the desired word is displayed (e.g., BACK). Then press [6] to accept the word and toggle back to the alphabet list.

4. For selection of the next word (e.g., DOOR), repeat step 3, as follows:
Press key [3] until the first letter of the next word appears (e.g., "D"). Then press [6] to display the first available word beginning with that letter (e.g. DAUGHTERS). Press [3] repeatedly until the desired word (e.g., DOOR) appears. To accept the word, press [6], which toggles back to the alphabet list.
5. When all desired words have been entered, press [8] to store the description in memory.
6. Enter *NN, where NN is the next zone that you want to review or for which you want to program a descriptor. To modify the descriptor, enter *NN again. To exit this mode, press "*00".

Adding Custom Words (will not be announced by 4285 Phone module)

You can add up to five installer-defined words can be added to the built-in vocabulary. Each of the five "words" can actually consist of a "word string" of one or more words, but no more than *ten* characters can be used for each word or word string.

	Custom words must begin with an <i>alphabetic</i> character. If a number or symbol is used as the first character, the word will not be saved.
---	--

When adding Custom Words in steps 3–6, the keypad keys perform the following functions:

- [3]** Advances through the alphabet in ascending order.
- [1]** Moves through the alphabet in descending order.
- [6]** Selects desired letter; moves cursor one space to right.
- [4]** Moves cursor one space to left.
- [7]** Inserts a space at the cursor location, erasing any character located there.
- [8]** Saves the new word in the system's memory.

1. Perform steps 1, 2, and 3 of **Programming the Descriptors** on a previous page.
Select CUSTOM WORD mode (enter "1") when the prompt **CUSTOM WORD ?** is displayed.
2. Enter the number ([1]–[5]) of the custom word or word string to be created (for example, if you are creating the *first* custom word or word-string, enter [1], for the *second*, enter [2], etc.). A cursor will now appear at the beginning of the second line.
3. **One of two methods of entering the custom word's characters can now be used** (refer to the *CHARACTER (ASCII) LIST of letters, numbers, and symbols on a following page*):
Method 1:
Press the [#] key, followed by the two-digit entry for the first letter you would like to display (e.g., [6][5] for "A"), **or...**
Method 2:
Use the [3] key to advance through the list of symbols, numbers, and letters. Use the [1] key to move back through the list.
4. When you have reached the desired character, press [6] to select it. The cursor will then move to the right, in position for the next character.
5. Repeat steps 3 and 4 to create the desired word(s). Note that the [4] key can be used to move the cursor to the left, if necessary, and that key [7] can be used to enter a blank (or erase an existing character). Remember, no word or word-string can exceed 10 characters.
6. Press the [8] key to save the custom word(s) and return to the **"CUSTOM WORD ?"** display.
Repeat steps 2–5 for other custom words to be entered. To change a custom word, just overwrite it. If no more are to be entered now, press [0] to return to the Descriptor entry. The custom word(s) will be automatically added to the built-in vocabulary.

When zone descriptors are being entered as described in step 6 of **Programming the Descriptors**, the custom word numbers are 250 to 254 for words 1 to 5 respectively.

When being entered as described in step 3 in **Alternate Method For Programming Zone Descriptors**, each word will be found at the end of the group of words that begin with the same letter as it does.

ALPHA VOCABULARY LIST (For Entering Zone Descriptors)

NOTE: Some rarely-used words appearing in previously published lists have been deleted from the list below. Use only this list for selecting zone descriptors.

000 (Word Space)	• 057 DOOR	• 106 LAUNDRY	R	155 RADIO	209 VALVE
• 001 AIR	• 059 DOWN	• 107 LEFT	• 156 REAR	210 VAULT	V
• 002 ALARM	061 DRAWER	108 LEVEL	157 RECREATION	212 VOLTAGE	W
004 ALLEY	• 062 DRIVEWAY	• 109 LIBRARY	159 REFRIGERATION		213 WALL
005 AMBUSH	• 064 DUCT	• 110 LIGHT	160 RF	• 161 RIGHT	214 WAREHOUSE
• 006 AREA	E	111 LINE	• 162 ROOM	• 216 WEST	• 217 WINDOW
• 007 APARTMENT	• 065 EAST	• 113 LIVING	163 ROOF	• 219 WING	220 WIRELESS
• 009 ATTIC	066 ELECTRIC	• 114 LOADING		S	X
010 AUDIO	067 EMERGENCY	115 LOCK	164 SAFE	165 SCREEN	222 XMITTER
• 012 BABY	068 ENTRY	116 LOOP	• 167 SERVICE	166 SENSOR	Y
• 013 BACK	• 069 EQUIPMENT	117 LOW	• 168 SHED	• 170 SHOP	223 YARD
• 014 BAR	• 071 EXIT	• 118 LOWER	169 SHOCK	171 SHORT	Z
• 016 BASEMENT	072 EXTERIOR	M	• 173 SIDE	174 SKYLIGHT	224 ZONE (No.)
• 017 BATHROOM	• 073 FACTORY	• 119 MACHINE	175 SLIDING	• 176 SMOKE	• 225 ZONE
• 018 BED	075 FAMILY	121 MAIDS	• 177 SMOKE	178 SONS	• 227 1
• 019 BEDROOM	• 076 FATHERS	122 MAIN	• 178 SONS	• 179 SOUTH	• 228 1ST
020 BELL	• 077 FENCE	• 123 MASTER	180 SPRINKLER	184 STORE	• 229 2
• 021 BLOWER	• 079 FIRE	• 125 MEDICAL	• 182 STATION	• 185 STORAGE	• 230 2ND
• 022 BOILER	• 080 FLOOR	126 MEDICINE	184 STORE	186 STORY	• 231 3
023 BOTTOM	081 FLOW	128 MONEY	• 185 STORAGE	190 SUPERVISED	• 232 3RD
025 BREAK	082 FOIL	129 MONITOR	186 STORY	191 SUPERVISION	• 233 4
• 026 BUILDING	• 083 FOYER	• 130 MOTHERS	191 SUPERVISION	192 SWIMMING	• 234 4TH
C	084 FREEZER	• 131 MOTION	192 SWIMMING	193 SWITCH	• 235 5
028 CABINET	• 085 FRONT	132 MOTOR	• 199 TEMPERATURE	200 THERMOSTAT	• 236 5TH
• 029 CALL	G	• 134 NORTH	200 THERMOSTAT	• 201 TOOL	• 237 6
030 CAMERA	• 089 GARAGE	135 NURSERY	• 201 TOOL	202 TRANSMITTER	• 238 6TH
031 CAR	• 090 GAS	O	202 TRANSMITTER	250 Custom Word #1	• 239 7
033 CASH	091 GATE	• 136 OFFICE	194 TAMPER	251 Custom Word #2	• 240 7TH
034 CCTV	• 092 GLASS	• 138 OPEN	196 TELCO	252 Custom Word #3	• 241 8
035 CEILING	093 GUEST	139 OPENING	197 TELEPHONE	253 Custom Word #4	• 242 8TH
036 CELLAR	094 GUN	• 140 OUTSIDE	• 199 TEMPERATURE	254 Custom Word #5	• 243 9
• 037 CENTRAL	H	142 OVERHEAD	200 THERMOSTAT		• 244 9TH
038 CIRCUIT	• 095 HALL	P	201 TOOL		
• 040 CLOSED	• 096 HEAT	143 PAINTING	202 TRANSMITTER		
• 046 COMPUTER	098 HOLDUP	• 144 PANIC	U		
047 CONTACT	099 HOUSE	145 PASSIVE	• 205 UP		
D	100 INFRARED	• 146 PATIO	• 206 UPPER		
• 048 DAUGHTERS	• 101 INSIDE	147 PERIMETER	• 207 UPSTAIRS		
049 DELAYED	102 INTERIOR	• 148 PHONE	• 208 UTILITY		
• 050 DEN	103 INTRUSION	150 POINT			
051 DESK	J	151 POLICE			
• 052 DETECTOR	104 JEWELRY	152 POOL			
• 053 DINING	• 105 KITCHEN	• 153 POWER			
054 DISCRIMINATOR	K	R			
055 DISPLAY		155 RADIO			
		• 156 REAR			

Note: Bulleted (•) words in **boldface type** are those that are also available for use by the 4285 Phone Module. If using a Phone module, and words other than these are selected for Alpha descriptors, the module will not provide annunciation of those words.

CHARACTER (ASCII) CHART (For Adding Custom Words)

32 (space)	42 *	52 4	62 >	72 H	82 R
33 !	43 +	53 5	63 ?	73 I	83 S
34 "	44 ,	54 6	64 @	74 J	84 T
35 #	45 -	55 7	65 A	75 K	85 U
36 \$	46 .	56 8	66 B	76 L	86 V
37 %	47 /	57 9	67 C	77 M	87 W
38 &	48 0	58 :	68 D	78 N	88
39 '	49 1	59 ;	69 E	79 O	89 Y
40 (50 2	60 <	70 F	80 P	90 Z
41)	51 3	61 =	71 G	81 Q	

Section 13. SEQUENTIAL MODE (for 5800 Series Wireless Transmitters)

(Use this mode only after all other zone information has been programmed, including transmitter loop numbers).

There are two methods of enrolling – you can enroll each transmitter into the system as you are entering the zone information in field *56 (the procedure will be found in the WIRELESS (RF) ZONE EXPANSION section), or you can enroll all the transmitters in *83 menu mode *after all other zone information has been entered in field *56.*

The enrolling method in *83 is called "sequential enrolling" and is described in this section.

As an option, the new sequential mode allows you to use a **5804 button-type transmitter as a "program tool."** The advantage of using a program tool is that it enables remote enrollment. You can move to the physical location of the transmitter to be enrolled, press the upper left-hand button of the program tool, and then trip the intended transmitter (see step 10 for operation). The transmitter that you use as the program tool can also be used as a transmitter in the system. If you plan to use an existing transmitter, it must first be enrolled into the system as its associated zones. You may then program it as the tool.

A Custom English keypad is required for the following procedures.

To enroll transmitters **sequentially**, **after** all other zone information has been programmed, do the following:

1. Enter Programming mode [**Installer Code**] + **8** + **0** on a Custom English keypad. Enter the Serial Number Sequential mode by pressing ***83**. The following prompt will be displayed.
2. If using a program tool, enter "1." If not using a tool, enter "0." If a tool has already been programmed, this prompt will not appear. If either not using a tool or one has already been programmed, skip to step 4.
3. If "1" is entered, the system will prompt for the transmitter's serial number. Enter the program tool's serial number using one of the following methods:
 - a) Enter the 7-digit serial number printed on the transmitter
or
 - b) Press any button on the transmitter. The keypad should beep twice and display the serial number of the tool.

Program Tool?
0 = No, 1 = Yes 0

00 Input S/N: L
 Ax x x-x x x x

00 Input S/N: L
 A123-4567 3

In this example, the serial number is A123-4567. Once enrolled, the upper left-hand button of the program tool can be pressed to ready the system for enrolling a transmitter into the system.

The serial number for the program tool will only remain in the system until the programming mode is exited. (Entering *97 will not delete the tool.)

Press [*] to continue.

Note that pressing the [#] key on the keypad will cause the system to back up to the "Program Tool ?" prompt.

Enter Zn Num.
(00 = Quit) 10

Zone Number Entered ↑

4. Enter the first zone number to be enrolled (e.g., zone 10).
Press [*] to continue.

The system will, starting with this zone number, search for the first transmitter which has **all** of the following attributes pre-programmed in Zone Programming:

- a) **An input type of RF, UR, or BR programmed**
- b) **A loop number programmed**
- c) **No serial number programmed**

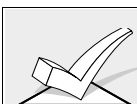

If the first zone number entered does **not** have one or more of the above attributes, the system will search its database for the first zone that does and will display it on the next screen.

10 Input S/N: L
Axxx xxxx

5. This prompt is displayed when the system has found the next zone which needs to be enrolled. The system will respond to the first serial number transmitted. A serial number may be enrolled by one of two methods:
- a) Enter the 7 digit serial number printed on the transmitter
or
 - b) Activate the transmitter by faulting or restoring the input you wish to use for that zone (e.g., press a button, open or close a door, etc.).

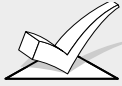

If you do **not** wish to enroll the zone displayed, press the [#] key on the keypad or the upper right-hand button on the program tool (a long beep will be heard to verify). The following prompt will appear:

10 Learn S/N?
0 = No, 1 = Yes 0

To enroll now, enter "1" (Yes). If "0" (No) is entered, the following prompt will appear if a program tool has already been programmed:

Enter Zn Num.
(00 = Quit) 12

Zone Number Entered ↑

Enter the next zone number to be enrolled (e.g., zone 12). The system will search for that zone and will display the prompt shown in the beginning of step 5. If you wish to exit the enroll mode completely, enter **00** and press [*].

10 Input S/N: L
A 022-4064 3
Serial #↑ Loop #↑

The system will enroll the serial number of the first transmitter heard, add the loop number entered to this serial number, display the serial and loop numbers, and cause the keypad to beep twice.



If the serial and loop number combination is already present in the system, a single long beep will be heard from the keypad. If this happens, the system will not display the serial number, but will wait for a transmission from another transmitter or transmitter loop input.

6. The system will then enter a confirmation mode so that the operation of the actual programmed input can be confirmed. Activate the loop input or button that corresponds to this zone. **We recommend that you confirm the programming of every transmitter before proceeding to the next zone.**

10 Confirmed
A022-4064 3

When the system sees activity on the appropriate input, it will beep three times and display the confirmation message. Press [*] or the upper left-hand button of the program tool when you are ready to enroll the next transmitter.



At any time during this step, you may press the [*] key on the keypad or the upper left-hand button of the program tool if you are satisfied with the serial and loop number combination that has been enrolled, regardless of whether or not the enrolled input has been "confirmed." This will ready the system to enroll the next transmitter.

If the incorrect transmitter has been enrolled, press the [#] key on the keypad or the upper right-hand button of the program tool to delete the serial number and return to the "LEARN S/N" prompt. A single long beep will be heard from the keypad to verify pressing of the upper right-hand button. Then, press "1" (Yes) or press the upper left-hand button of the program tool (a single short beep will verify the system is ready for enrolling) and re-activate the proper transmitter or transmitter loop input.

Enter Zn Num. (00 = Quit) 15

7. The system will search for the next zone that does not have a serial number associated with it. If one is found, the prompt in step 5, along with the appropriate zone number, will be displayed. Follow steps 5 and 6 for the remaining wireless zones.
8. After all wireless zones have been displayed, whether enrolled or not, the "Enter Zn Num." prompt will appear.
Enter "00" to exit the serial number Sequential mode and return to the data field programming mode.

When you have finished programming all zones, test each using the system's TEST mode (see *TESTING THE SYSTEM* section).

Do not use the Transmitter ID Sniffer mode for testing, as it will only check for transmission of one zone on a particular transmitter, and NOT the zones assigned to each additional loop.

Section 14. SYSTEM COMMUNICATION

This section provides an explanation of formats this system accommodates for reporting alarms and other system conditions to the central station. The process of a successful transmission consists of both the method of communication between the control panel and the central station receiver and the actual way the information is sent and displayed at the central station.

Report Code Formats

When the panel calls the central station receiver, it waits to hear a "handshake" frequency from the receiver to confirm that the receiver is on-line and ready to receive its message. Once the panel hears the handshake it is programmed to listen for, it sends its message. The panel then waits for a "kissoff" frequency from the receiver acknowledging that the message was received and understood.

If the handshake frequency is not given or is not understood by the panel, the panel will not send its message. Once the handshake frequency is received and understood by the panel, the panel will send its message. If there is an error in the transmission (the receiver does not receive a "valid" message), the kissoff frequency will not be given by the central station receiver.

The panel will make a total of eight attempts to the primary telephone number and eight attempts to the secondary telephone number (if programmed) to get a valid message through. If the panel is not successful after its numerous attempts, the keypad will display "Communication Failure" (Alpha keypad) or "FC" (Fixed-word keypad).

The following chart defines the three sets of (handshake/kissoff) frequencies that the panel supports and the different formats that can be sent for each.

FORMAT	HANDSHAKE	TRANSMITS DATA	KISSOFF	TRANSMIT TIME
Low Speed 3+1 4+1 4+2	1400Hz	1900Hz (10PPS)	1400Hz	Under 15 secs. (Standard report)
Sescoa/Rad 3+1 4+1 4+2	2300Hz	1800Hz (20PPS)	2300Hz	Under 10 secs. (Standard report)
Express 4+2	1400–2300Hz	DTMF (10 cps)	1400Hz	Under 3 secs.
Contact ID	1400–2300Hz	DTMF (10 cps)	1400Hz	Under 3 secs.

The following describes each format in greater detail.

3+1 and 4+1 Standard Formats	Comprise a 3- (or 4-) digit subscriber number and a single digit report code (e.g. Alarm, Trouble, Restore, Open, Close, etc.).
3+1 and 4+1 Expanded Formats	Comprise a 3- (or 4-) digit subscriber number, and a two-digit report code. The first digit is displayed on the first line, followed by a second line where the first digit is repeated 3 (or 4) times and followed by the second digit. This is the "expanded" digit.
4+2 Format	Comprises a 4-digit subscriber number and 2-digit report code.
Ademco Contact ID Reporting Format	Comprises a 4-digit subscriber number, 1-digit event qualifier ("new" or "restore"), 3-digit event code, and 3-digit zone number, user number, or system status number (see the following page).

Report	3+1/4+1 Standard	3+1/4+1 Expanded	4+2
Alarm	SSS(S) A	SSS(S) A AAA(A) Z	SSSS AZ
Trouble	SSS(S) T	SSS(S) T TTT(T) t	SSSS Tt
Bypass	SSS(S) B	SSS(S) B BBB(B) b	SSSS Bb
AC Loss	SSS(S) E	SSS(S) E EEE(E) A _C	SSSS EA _C
Low Batt	SSS(S) L	SSS(S) L LLL(L) L _B	SSSS LL _B
Open	SSS(S) O	SSS(S) O OOO(O) U	SSSS OU
Close	SSS(S) C	SSS(S) C CCC(C) U	SSSS CU
Test	SSS(S) G	SSS(S) G GGG(G)g	SSSS Gg
Restore Alarm	SSS(S) R	SSS(S) R RRR(R) Z	SSSS RZ
AC Restore	SSS(S) R _A	SSS(S) R _A R _A R _A R _A (R _A)A _C	SSSSR _A A _C
LoBat Res.	SSS(S) R _L	SSS(S) R _L R _L R _L R _L (R _L)L _B	SSSS R _L L _B
Trouble Res.	SSS(S) R _T	SSS(S) R _T R _T R _T R _T (R _T)t	SSSS R _T t
Bypass Res.	SSS(S) R _B	SSS(S) R _B R _B R _B R _B (R _B)b	SSSS R _B b

Where:

Where:

SSS or SSSS = Subscriber ID

A = Alarm Code–1st digit

Z = Typically Zone Number*–2nd digit

Tt = Trouble Code (1st & 2nd digits)

Bb = Bypass Code (1st & 2nd digits)

EA_C = AC Loss Code (1st & 2nd digits)

LL_B = Low Battery Code(1st & 2nd digits)

O = Open Code–1st Digit

C = Close Code–1st Digit

U = User Number (in hex)

Gg = Test Code (1st & 2nd digits)

R = Restore Code (Alarm)

R_Tt = Restore Code (Trbl)1st & 2nd digits

R_Bb = Restore Code (Byps)1st & 2nd digits

R_AA_C = Restore Code (AC)1st & 2nd digits

R_LL_B = Restore Code (Bat)1st & 2nd digits

*Zone numbers for: [∗] & [#], or [B] = 99 [1] + [∗], or [A] = 95 Duress = 8
[3] + [#], or [C] = 96 Tamper = 9

Ademco Contact ID Reporting takes the following format:

CCCC Q EEE GG ZZZ

where: CCCC = Customer (subscriber) ID

Q = Event qualifier, where:

E = new event , and R = restore

EEE = Event code (3 hexadecimal digits)

Note: For a complete list of event codes, refer to the central office receiver manual.

GG = Always 00.

ZZZ = Zone/contact ID number reporting the alarm, or user number for open/close reports. System status messages (AC Loss, Walk Test, etc.) contain zeroes in the ZZZ location.

TABLE OF CONTACT ID EVENT CODES

Code	Definition
110	Fire Alarm
121	Duress
122	Alarm, 24-hour Silent
123	Alarm, 24-hour Audible Panic
131	Alarm, Perimeter, Burg.
132	Alarm, Interior, Burg.
134	Alarm, Entry/Exit, Burg.
135	Alarm, Day/Night, Burg.
150	Alarm, 24 Hour Auxiliary
301	AC Power
302	Low System Battery/Battery Test Fail
333	Expansion Module Fail
353	Long Range Radio Trouble
373	Fire Loop Trouble

Code	Definition
374	Exit Error Alarm
380	Trouble (Global)
383	RF Sensor Tamper
384	RF Sensor Low Battery
401	O/C by User
406	Cancel by User
407	Remote Arm/Disarm (Download)
408	Quick Arm AWAY/MAX
441	Armed STAY/INSTANT, Quick Arm STAY/INSTANT
570	Bypass
601	Test, Manually Triggered
602	Periodic Test
606	AAV to follow

Communication Programming

Introduction

This section provides instructions for programming those fields that affect communications between the control and the central station.

Programming Procedure

1. With at least one Alpha keypad (5137AD or 6139) connected to the system, power up the system. If necessary, refer to the *FINAL POWER UP* section for the power-up procedure. If you had previously connected the AC transformer to the control panel, you need only plug in the transformer (to 120VAC outlet) to power up the system.
2. Enter the programming mode by keying the following on the Alpha keypad: **Installer code (4 1 1 1) + 8 + 0.**

Fields *40, *41, *42:

Enter up to the number of digits shown. Do not fill unused spaces.

Enter 0–9,

+ 11 for '*'

+ 12 for '#'

+ 13 for a pause
(2 secs)

Press *40 PABX ACCESS CODE

Enter up to 4 digits if PABX is needed to access an outside line. If fewer than 4 digits are needed to be entered, exit by pressing [*] and next field number (e.g., 41). To clear entries from field, press *40*.

Press *41 PRIMARY PHONE No.

Enter up to 12 digits. If fewer than 12 digits entered, exit by pressing [*] and next field number (e.g., 42). To clear entries from field, press *41*.

Press *42 SECONDARY PHONE No.

Enter up to 12 digits. If fewer than 12 digits entered, exit by pressing [*] and next field number (e.g., 43). To clear entries from field, press *42*. **If using the Paging feature, enter the pager number as the secondary phone number.**

Press *43 SUBSCRIBER ACCOUNT. No.

(Central Station Account Number).

Enter 0–9; # + 11 for B; # + 12 for C; # + 13 for D; # + 14 for E; # + 15 for F (default).

Enter * as the fourth digit if a 3-digit account number (for 3+1 dialer reporting format) is used. Enter 0 as the first digit of a 4-digit account number for Nos. 0000–0999. End field by pressing * (and press next field).

See the blank Programming Form in the separate **Programming Guide** for examples of Account No. entries.

Field *43 is also used as the Long Range Radio Subscriber Account Number

Example 1. Pager displays:

This indicates that Subscriber No. 1234's system is reporting an Alarm (911), due to zone 4 being faulted (004).

Example 2. Pager displays:

This indicates that Subscriber No. 1234's system is reporting an opening (001) by User 5 (005).

Note that no restore reports are sent to the pager.

Important: Do not use AAV when Paging or Alarm Reports are being sent to a Secondary number. If this is done, the call to the Secondary number by the communicator after the alarm report will prevent the AAV from taking control of the phone line, and the AAV "Listen in" session cannot take place.

Press *48 15-SECOND DIALER DELAY, BURGLARY

Enter 0 for no, or 1 for yes. Default is 0 (no delay).

Press *49 PERIODIC TEST REPORT

Select the desired test report interval.

0 = none; 1 = 24 hours; 2 = weekly; 3 = 30 days. Default is 0 (none). Test Report Code entered in field * 64 is sent.

Reports with Subscriber No.

Press *50 SESCOA/RADIONICS SELECT

0 = Radionics (0-9, B-F reporting)

1 = SESCOA (0-9 only reporting)

Select 0 for all other formats. Default is 0.

**TO PROGRAM SYSTEM
STATUS AND
RESTORE REPORT
CODES
(*60 - *68, *70 - *75)**

With a 3+1 or 4+1 Standard Format: Enter a code in the *first digit* box: 1-9, 0, B, C, D, E, or F. Enter "# + 10" for 0, "# + 11" for B, "# + 12" for C, "# + 13" for D, "# + 14" for E, "# + 15" for F.

A "0" (*not* "# + 10") in the *first digit* box will disable a report.

A "0" (*not* "# + 10") in the *second digit* box (if any) will result in automatic advance to the next field when programming.

With an Expanded or 4+2 Format: Enter codes in *both* boxes (1st and 2nd digits) for 1-9, 0, or B-F, as described above.

A "0" (*not* "# + 10") in the *second* box will eliminate the expanded message for that report.

A "0" (*not* "# + 10") in *both* boxes will disable the report.

With Ademco Contact ID Reporting: Enter any digit (other than "0") in the *first* box, to enable zone to report. This is an "enabling" code only and is disregarded in the actual reporting to the central office. Entries in the *second* boxes will be ignored.

A "0" (*not* "# + 10") in the *first* box will disable the report.

Examples:

For Code 3 (Single Digit), enter:

For Code 32 (Two Digits), enter:

For Code B2 (Hexadecimal) enter:

Press *60 TROUBLE REPORT CODE

This will be sent if a zone goes into trouble.

Press *61 BYPASS REPORT CODE

This will be sent when a zone is manually bypassed.

Press *62 AC LOSS REPORT CODE

Reports with Subscriber No. Timing of this report is random with up to a 48-minute delay. The Restore report has a random delay of up to about 12 minutes. If AC restores before the report goes out, there is no AC restore report.

Press *63 LOW BAT REPORT CODE

This will be sent when a low battery condition exists in the system's standby battery.

Note: Connection to the standby battery is checked every 3 minutes (CSFM requirement).

Press *64 TEST REPORT CODE

This is sent periodically to test that the communicator and phone lines are operational (frequency of report is selected in field *51).

Press*65 OPEN/EXIT ALARM REPORT CODE, 1st DIGITS

Open Report Code : To enable, enter a code (or 0 to disable) in the left-hand box (see box on previous page).

For expanded or 4+2 reporting, 2nd digit = User #.

Exit Alarm Report Code: To enable, enter a code (or 0 to disable) in the right-hand box (see box above). If enabled, **any alarm from an exit or interior zone occurring within two minutes after the end of the exit delay** will send a special message indicating exit alarm to the central station, and a zone indication and "Exit Alarm" or "EA" is displayed on the keypad.

If an exit or interior zone contains a fault as the exit delay ends, the local bell and keypad sound continuously.

a) *If the subscriber then disarms the system before the ensuing ENTRY delay ends,* no message is transmitted to the central station, but a zone indication and "Canceled Alarm" or "CA" is displayed on the keypad.

b) *If the system is not disarmed before that entry delay ends,* a special message indicating Exit Alarm is sent to the central station and a zone indication and "Exit Alarm" or "EA" is displayed on the keypad.

*For expanded or 4+2 reporting, a 2nd digit is sent, and is the same as the 2nd digit of the zone alarm report code programmed in field *56.*

For Contact ID reporting, Event code 374 and the zone number is sent.

There is no restore message for Exit Alarm report.

Press *66 ARM AWAY/STAY REPORT CODES

This option allows for independent programming of AWAY and STAY reports . 2nd digit of Report is User No., if expanded or 4+2 reporting is selected.

Press *67 RF XMTR. LOW BATTERY REPORT CODE

This is sent in the event that a wireless transmitter low battery condition exists.

Press *68 CANCEL REPORT CODE

This is sent upon disarming of the system after an alarm condition was reported.

Press *70 ALARM RESTORE REPORT CODE, 1st DIGIT

This is sent when the zone that caused an alarm is restored to its non-faulted condition. 2nd digit is automatically sent as the 2nd digit of the zone alarm report code programmed in field *56, if expanded or 4+2 reporting is selected.

Press *71 TROUBLE RESTORE REPORT CODE

This is sent when a trouble in a zone is restored.

Press *72 BYPASS RESTORE REPORT CODE

This is sent when a zone that has been bypassed is un-bypassed.

Press *73 AC RESTORE REPORT CODE

This is sent when AC power has been restored after an AC power outage.

Press *74 LOW BAT RESTORE REPORT CODE

This is sent when a system low battery condition is restored to normal.

Press *75 RF XMTR. LOW BATTERY RESTORE CODE

This is sent when a transmitter that previously sent in a low battery message has sent a message indicating it no longer has a low battery condition.

Press *92 NUMBER OF REPORTS IN ARMED PERIOD

This option can be used to limit the number of messages (alarm & alarm restore reports) sent to the central station in an armed period. "0" limits reports to a total of 10; "1" allows an unlimited number of reports.

Press *94 DOWNLOAD PHONE NUMBER

Enter up to 12 digits; 0-9, # + 11 for "*", # + 12 for "#", # + 13 for a pause. Do not fill unused spaces. End field by entering "*". To clear entries, press *94*.

Press *95 RING DETECTION COUNT FOR DOWNLOADING

Refer to the chart below and program this field accordingly.

Voice Module	Answering Machine	Downloading	Field *95 Programming
Yes	No	No	Set for value other than "0" (1-14). This will enable the control panel to answer the phone call. Otherwise, it will not be possible to access the Module.
Yes	Yes	No	Set for a value higher than the number of rings for which the answering machine is set. Example: if machine is set for 4 rings, use value 5 or higher. This is recommended so that the Phone module can still be accessed if the answering machine is turned off and does not answer the phone call.
Yes	No	Yes	Set for value other than "0" (1-14).
Yes	Yes	Yes	"15" to bypass answering machine.
No	No	No	Enter "0"
No	Yes	No	Enter "0"
No	No	Yes	Enter 1-14
No	Yes	Yes	Enter 15. See Important Note below.

Important Note: If "15" is entered in field *95 to bypass an answering machine, and a 4285 Phone Module is included in the installation, you should note the following: When calling in from an off-premises phone (to receive a status report or execute a command), the user should make the initial call, allow 1 to 3 rings only, and hang up. Then call in again – the Phone Module will now seize the line, and 2 long tones will heard, followed by the usual voice prompt for the 2-digit phone access code. If this procedure is not followed, Phone Module operation will not be possible.

***96 INITIALIZE DOWNLOAD ID AND SUBSCRIBER ACCT. No. FOR DOWNLOADING (No data entry required)**

This completes the communication programming.

Exit the programming mode by keying *99.

Refer to the *TESTING THE SYSTEM* section to check system operation.

Section 15. TESTING THE SYSTEM

Test Procedure

After installation is completed, the System should be carefully tested, as follows:

1. With the System in the disarmed state, check that all zones are intact. If a **NOT READY** message is displayed, press the [*****] key to display the faulted zone(s). Restore faulted zone(s) if necessary, so that the **READY** message is displayed.
2. Enter the security code and press the **TEST** key.
The external sounder will sound for 1 second. If the backup battery is discharged or missing, the sounder may not turn on and a **LOW BATTERY** report will be transmitted with a **TEST** report.
Note that the keypad will beep once every 40 seconds as a reminder that the system is in the Test Mode.
3. Fault and restore every sensor individually to assure that it is being monitored by the system. Each time a protection zone is faulted, the keypad will sound 3 beeps, and the identification of each faulted protection zone should appear on the keypad display.
Note: For 5800 wireless systems, triggering a zone set to Arm–Away, Arm–Stay, or Disarm will take the system out of the **TEST** mode and cause that action.
4. Walk in front of any interior motion detectors (if used) and listen for the required sound as movement is detected. The identification of the detector should appear on the display when it is activated.
Note: Wireless motion detectors (Passive Infrared units) will send signals out only if they have been inactive for 3 minutes.
5. Follow the manufacturer's instructions to test all smoke detectors, to ensure that all are functioning properly. The identification of each detector should appear on the display when each is activated.
6. Turn off the test mode by entering the security code and pressing the **OFF** key.

Alarm messages will be sent to the Central Station during the following tests. Notify them *in advance* that tests will be in progress.

7. Arm the system (**STAY**) and fault one or more perimeter zones. After 15 seconds, silence alarm sounder(s) by entering the security code and pressing **OFF**.
Arm the system **AWAY**, and check the Entry/Exit zones for the programmed exit and entry delays.
8. Check the keypad-initiated alarms that are in the system by using the Panic keys (or key pairs on some keypads). If a key (or key pair) has been programmed for audible emergency, the keypad will emit a steady alarm sound, and **ALARM** and **zone number** will be displayed.
If a key (or key pair) has been programmed for silent emergency, there will be no audible alarms or displays, but a report will be sent to the Central Station.
If a key (or key pair) has been programmed for Fire, the keypad and external sounder will emit an interrupted alarm sound, and **ALARM**, **FIRE**, and **zone number** will be displayed.
Silence alarms by entering the security code and pressing **OFF**.
9. If Output Relay Units have been installed, test their programmed action.
10. Notify the Central Station when all tests are finished, and verify results with them.

(Continued)

To test the wireless part of the system and the RF Receiver, perform the two following tests: **Transmitter Sniffer Mode** and **Go/NoGo Test Mode** .

TRANSMITTER SNIFFER MODE

Make sure the system is disarmed before trying to enter this mode.

Key **Installer code + # + 3**. This initiates a procedure that will check that all 5700 series transmitters have been properly programmed.

Note: If the communicator is in the process of sending a report to the Central Station, the system will not go into the Sniffer mode. If so, wait a few minutes, and try again.

The keypad will display all zone numbers of wireless units programmed into the system. As the system receives a signal from each of the transmitters, the zone number of that transmitter will disappear from the display. The transmitter codes may be checked upon installation, or in an installed system.

All the wireless zone numbers should disappear after about 1-1/2 hours.

Note: Any transmitter that is not properly entered into the system will not turn off its zone number.

Exit the Transmitter Sniffer mode by keying **Installer code + OFF**.

GO/NO GO TEST MODE

By keying **Installer code + # + 4**, a mode similar to the test mode is entered, but the wireless receiver gain is reduced. Checking in this mode not only assists in determining good mounting locations for the transmitters when the system is being installed, but also verifies that the RF transmission has sufficient signal amplitude margin for the installed system.

1. Enter the **Installer Code + # + 4**
2. Once transmitters are placed in their desired locations and the approximate length of wire to be run to sensors is connected to the transmitter's screw terminals, fault each transmitter. *Do not conduct this test with your hand wrapped around the transmitter as this will cause inaccurate results.*
 - The keypad will beep three times to indicate signal reception.
 - If the keypad does not beep, re-orient or move the transmitter to another location. Usually a few inches in either direction is all that is required.
3. Exit the G0/NoGo mode by keying **Installer code + OFF**.

TO THE INSTALLER

Regular maintenance and inspection (at least annually) by the installer and frequent testing by the user are vital to continuous satisfactory operation of any alarm system.

The installer should assume the responsibility of developing and offering a regular maintenance program to the user as well as acquainting the user with the proper operation and limitations of the alarm system and its component parts. Recommendations must be included for a specific program of frequent testing (at least weekly) to insure the system's proper operation at all times.

Section 16. SYSTEM OPERATION

Security Codes

Installer Code

The installer programs the 4-digit Installer Code initially as part of the programming procedure. The factory default Installer code is "4-1-1-1", but may be changed in field *20. **Note:** The Installer Code is defined as User #1. The Installer code is the only code that can allow re-entry into programming mode. In normal operation mode, only the Master code can be used to enter the User codes (refer to *Assigning the Master Code*).

See *MECHANICS OF PROGRAMMING* section in the **PROGRAMMING GUIDE** manual for details on exiting the programming mode via *98 or *99.

Assigning the Master Code

In normal operation mode, assign the 4-digit Master Code as follows:

Installer Code + 8 + 2 + 4-digit Master Code

Note: The Master Code is defined as User #2.

Changing the Master Code

In normal operation mode, the Master code can be changed by entering:

Master Code + 8 + 2 + New Master Code + New Master Code again

User Codes

In normal operation mode, the Master security code can be used to assign up to 4 secondary 4-digit security codes. It can also be used to remove secondary codes from the system (individually).

To assign (or change) a Secondary security code, enter (via keypad):

Master Code + [CODE key] + User # (3–6) + desired 4-digit Secondary Code

The system will emit a single beep when each secondary code has been successfully entered.

To delete a Secondary security code, enter (via keypad):

Master Code + [CODE key] + User # (3–6)

Notes:

- All Master and Secondary security codes permit access to the system for arming, disarming, etc.
- If a secondary code is inadvertently repeated for different users, the lower user number will take priority.
- Opening and closing reports are sent for the Master code as No. 02, with the appropriate subscriber number. Secondary user codes are sent as Nos. 3 through 6 respectively, with the appropriate subscriber number.

Duress Code

Important: This code is useful only when the system is connected to a central station.

This feature is intended for use when you are forced to disarm or arm the system under threat. When used, the system will act normally, but can silently notify the central station of your situation, if that service has been provided. The Duress code may be any 4-digit code assigned to User Number 8.

To program a Duress code:

1. Enter Master Code.
2. Press the CODE [8] key.
3. Press the [8] key again (8 = Duress code User No.).
4. Enter the desired 4-digit Duress Code. The keypad will beep once.

Note: The Duress code must differ from the Master Code or any other User's Code.

To change the Duress code:

Repeat steps 1, 2, and 3, and then step 4 with the new Duress Code.

To delete the Duress code:

Perform steps 1, 2, and 3, and then stop. When the keypad beeps once it signifies that the code has been deleted.

Keypad Functions

General Information

Note that if you enabled QUICK ARM (field *21), the [#] key can be pressed instead of entering the security code, for any of the arming procedures (Away, Stay, Instant, Maximum, etc.). The security code is *always* required, however, when disarming the system.

NOTE: The "Quick Arm" feature will function only if the Master Code has been programmed (see *Assigning the Master Code* on the previous page).

The keypad allows the user to arm and disarm the system, and perform other system functions, such as bypassing zones, and display zone descriptors. Zone and system conditions (alarm, trouble, bypass) are displayed in the Display Window.

When an alarm occurs, keypad sounding and external sounding will occur, and the zone(s) in alarm will be displayed on the keypad. Pressing any key will silence the keypad sounder for 10 seconds. Disarming the system will silence both keypad and external sounders. When the system is disarmed, any zones that were in an alarm condition during the armed period will be displayed (memory of alarm). To clear this display, simply repeat the disarm sequence (enter the security code and press the OFF key) *again*.

The keypads also feature chime annunciation, and 3 panic key pairs, or individual panic keys (depending on keypad type – see *Panic Keys* on next page), for silent, audible, fire or personal emergency alarms. These keys can notify the central station of an alarm condition, if that service is connected.

Arming Functions

The following is a brief list of system commands. For detailed information concerning system functions, refer to the User's Manual.

Disarmed, Not Ready Before arming, the system must be in the READY condition (all zones must be intact). If the "NOT READY" message appears, press the READY [*] key to display faulted zones.

Arming Away Enter code + AWAY [2].

Arming Stay Enter code + STAY [3].

Arming Instant Enter code + INSTANT [7].

Arming Maximum Enter code + MAXIMUM [4].

Quick Arming Simply press [#] key in place of code, then press (if enabled) AWAY, STAY, INSTANT, or MAXIMUM to arm system as desired. Note that the [#] key cannot be used in place of code when disarming the system.

Disarming Enter code + OFF [1].

Bypassing Zones Enter code + BYPASS [6] + zone number(s).

Forced (Quick) Bypass To automatically bypass all faulted zones, use (if enabled) the "Quick Bypass" method:
Enter code + BYPASS, then wait for all open zones to be displayed. Arm when display indicates "Bypass" and "Ready to Arm".

Chime Mode Enter code + CHIME [9].
To turn chime off, enter code + CHIME again.

SUMMARY OF ARMING MODES

Arming Mode	Features for Each Arming Mode			
	Exit Delay	Entry Delay	Perimeter Armed	Interior Armed
AWAY	Yes	Yes	Yes	Yes
STAY	Yes	Yes	Yes	No
INSTANT	Yes	No	Yes	No
MAXIMUM	Yes	No	Yes	Yes

Panic Keys

There are three individual panic keys or, on some keypads, panic key pairs. If programmed, they can be used to manually initiate alarms and send a report to the central station.

Each key (or key pair) can be individually programmed for 24-hour Silent, Audible, Personal or Fire Emergency responses. The panic function is activated when both keys of the appropriate key pair are pressed at the same time, or the appropriate lettered key is pressed for at least 2 seconds.

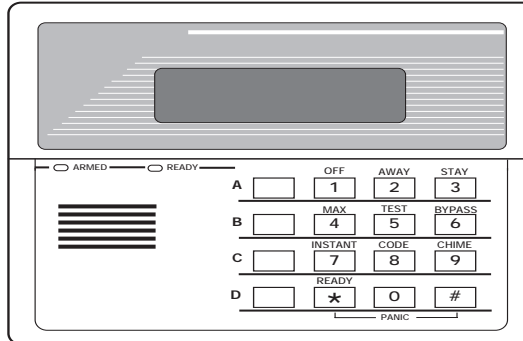

Shown on the left is a typical keypad with individual Panic keys (shown lettered).

The panic functions are identified by the system as follows:

Keys	Displayed as Zone
[A], or [1] & [*]	95
[B], or [*] & [#]	7
[C], or [3] & [#]	96

Notes:

- Keys [A], [B], [C] are not on all keypads.
- Key [D], if present, is not active here.

Important: For the Silent Panic functions to be of practical value, the system must be connected to a central station.

4285 Phone module (if used)

Refer to the separate instructions supplied with the Phone module for information concerning its operating procedures.

Note: The Phone module **cannot** be used to add user codes in this system. User codes must be added by using a wired keypad.

Relay Outputs (if used)

If relay outputs are used, two keypad entries available to the user are included among the system operation choices (34 and 35) that may be programmed (see the *RELAY OUTPUTS* section). They can manually activate or deactivate the relay(s) for starting or stopping some action, such as turning lights on or off, etc.

These keypad entries are: **Security Code + [#] + [7]**
and **Security Code + [#] + [8]**

Note: Whichever entry is used to start/stop the action cannot also be used to stop/start it. The opposite action must either be performed by the other keypad entry or by some other event or operation offered in the programming section.

Exit Alarm Displays (if programmed)

- **A display of "CANCELED ALARM" or "CA" and a zone indication** will appear if an exit or interior zone contained a fault during closing at the time the exit delay ended (e.g., exit door left open), *but the system was disarmed during the entry delay time*. The alarm sounder and keypad sound continuously, but stop when the system is disarmed. No message will be transmitted to the central station.
- **A display of "EXIT ALARM" or "EA" and a zone indication** will appear if an exit or interior zone contained a fault during closing at the time the exit delay ended, *but the system was NOT disarmed during the entry delay time*. The alarm sounder and keypad sound continuously until the system is disarmed (or timeout occurs). An "exit alarm" message is sent to the central station.

(Continued)

- The **"EXIT ALARM" display, etc.** will also result if an alarm from an exit or interior zone occurs within two minutes after the end of an exit delay.

In any of the previous cases, use a second OFF sequence (code plus OFF key) to clear the display.

Trouble Conditions (See Troubleshooting Guide also)

General Information	<p>The word "CHECK" on the keypad's display, accompanied by a rapid "beeping" at the keypad, indicates that there is a trouble condition in the system. The audible warning sound can be silenced by pressing any key. Instruct users to call for service immediately upon seeing any of the following messages.</p>
"Check" and "Battery" Displays	<ul style="list-style-type: none"> • A display of "CHECK" and one or more zone numbers indicates that a problem exists with the displayed zone(s) and requires attention. • A display of "CHECK" and 09 indicates that communication between control and a zone expander or wireless receiver is interrupted. Check the wiring and DIP switch settings on the units. • If there are wireless sensors in the system, the CHECK condition may also be caused by some change in the environment that prevents the receiver from receiving signals from a particular sensor. • A display of "BAT" (Fixed-word keypads) or "SYSTEM LO BAT" (Alpha keypads) with no zone number indicates that the system's main standby battery is weak. • A display of "BAT" (Fixed-word keypads) or "LO BAT" (Alpha keypads) with a zone number and a once per minute "beeping" at the keypad indicates that a low battery condition exists in the wireless sensor displayed (zone "00" indicates a wireless keypad). If the battery is not replaced within 30 days, a CHECK display may occur. Note: Some wireless sensors contain a non-replaceable long-life battery which requires replacement of the entire unit at the end of battery life (e.g., Nos. 5802, 5802CP).
Power Failure	<ul style="list-style-type: none"> • If there is no keypad display at all, and the POWER indicator (if present) is not lit, operating power for the system has stopped and the system is inoperative. Note: The control panel will power up in its previous state (armed or disarmed) after a complete power failure, but will not retain any memory of bypasses. • If the message "AC LOSS" (Alpha keypads) or "NO AC" (Fixed-word keypads) is displayed, and the POWER indicator (if present) is off, the keypad is operating on battery power only. Note: There is a random delay up to 48 minutes before the system will report an AC failure to the central station. The keypad response is about 6 seconds. The restore report has a random delay of up to 12 minutes (if the AC failure report was sent). • If the battery standby capacity is used up during a prolonged AC power outage, the control's auxiliary power will shut down to minimize deep discharge of the battery.
Other Displays (Fixed Word displays are in parentheses)	<p>Busy-Standby (dl). If this remains displayed for more than 1 minute, the system is disabled.</p> <p>Modem Comm (CC) The system is in communication with the central station for change of function or status verification.</p> <p>Comm. Failure (FC) A communication failure has occurred.</p> <p>Open Circuit (OC) The keypad is not receiving signals from the control and sees an open circuit.</p> <p>Long Rng Trbl (bF) Back-up LRR communication failure.</p>

Section 17. TROUBLESHOOTING GUIDE

SYSTEM (including Wireless)

SYMPTOM	POSSIBLE CAUSE	REMEDY
1. Transmitter signal not received at 4281/5881.	1a. Transmitter or 4281/5881 not properly powered. 1b. If Transmitter is 5827/5827BD, house ID code not set in field *24, or transmitter not set to same house code set in that field. 1c. Transmitter located too far from 4281/5881. 1d. Metal shielding between transmitter and 4281/5881. 1e. Transmitter malfunctioning. 1f. 4281/5881 malfunctioning. 1g. Transmitter No. (zone) not programmed. 1h. 4281/5881 address incorrect. 1i. Field *22 not set properly.	1a. Check or change transmitter's battery. Check the control's AC power. 1b. Check code switches inside transmitter. Must match with RF House Code programmed in control. 1c. Move transmitter or 4281/5881. 1d. Check for large metal obstructions, then relocate transmitter if necessary. 1e. Verify by activating 4281/5881 with another, similar transmitter. If O.K. now, return defective transmitter. 1f. Verify by making sure other transmitters cannot activate 4281/5881. If defective, replace and return original 4281/5881. 1g. Verify programming. 1h. Set DIP switch for address "0". 1i. Set field *22 to "1" for 4281 RF receiver, or "2" for 5881 RF receiver
2. Transmitter zone number appears during Go/NoGo test mode, but does not clear.	2a. Transmitter zone type (ZT) is set to 00 (Not Used). 2b. Transmitter battery not installed. 2c. 5700 System transmitter's DIP switch not set properly (house ID and transmitter ID). 2d. 5800 System transmitter serial No. not entered in system. 2e. With 5700 System, no response at all to <i>any</i> transmitter.	2a. Set ZT to a valid active zone type in field *56. 2b. Install proper battery. 2c. Check and set the DIP switch. 2d. Enter unit's serial No. in field *56. 2e. Check 4281 receiver.
3. Low Battery message on keypad.	3a. "Bat" or "System Lo Bat" (no zone Nos.) 3b. "Bat" or "Lo Bat" + "00". 3c. "Bat" or "Lo Bat" + "nn".	3a. System battery is low or missing. 3b. Remote RF keypad battery is low. 3c. Transmitter for zone "nn" has a low battery.
4. Periodic beep(s) from keypad.	4a. System is in TEST mode. 4b. A wireless transmitter low battery has occurred and is displayed. 4c. A supervision CHECK has occurred.	4a. Enter "Code" + OFF to exit TEST mode. 4b. Enter "Code" + OFF and replace the battery. 4c. Check the wireless transmitter indicated. Restore communication to the RF receiver to cancel the condition.
5. With 5800 RF System, no response to a transmitter in normal operation, although zone number clears during Go/NoGo mode.	Put control in TEST mode. If zone does not respond, try operating the tamper switch or another input to the transmitter. 5a. If another input causes the zone to be displayed, the wrong loop input was entered when programming. 5b. If no response at all from this transmitter, this physical transmitter has not been entered into the system. Go/NoGo display is being cleared by another unit programmed for this zone.	5a. Delete input's serial number (not the zone), and enter the proper loop input (see field *56). 5b. Determine which transmitter is programmed for this zone and reprogram as necessary.
6. Nuisance or phantom alarm.	6a. Sensors not properly installed, wired, or monitored. 6b. Universal transmitter (5715/5817) programmed wrong.	6a. Check installation to see if in accordance with established procedure. 6b. Check programming switches on transmitter.
7. Intrusion alarm for no apparent reason.	7a. Protected door or window opened while system armed. 7b. Improper user operation of exit/entry delays. 7c. Magnets located too far from switches, and/or doors and windows not properly aligned.	7a. Check with all occupants of protected premises. 7b. Check setting of entry delay. Exit delay is 15 seconds longer than the entry delay time. Remind user of same. 7c. Check all openings for proper switch and magnet orientation.

(Continued)

TROUBLESHOOTING GUIDE (continued)

SYMPTOM	POSSIBLE CAUSE	REMEDY
7. Intrusion alarm for no apparent reason. (continued)	7d. Magnetic contacts improperly connected or wire broken.	7d. Check wiring connections. Be sure wires are properly stripped and are tightly fastened to screw terminals.
	7e. Entry door programmed as "Instant"	7e. Check and revise programming. Re-program transmitter number.
	7f. Loose fitting door or window being rattled by wind or vibrations.	7f. Mount magnet closer to magnet.
8. Repeated low battery signal.	8a. Transmitter located where temperature drops below 32°F.	8a. Change location. Use magnetic contacts to protect opening.
	8b. Poor quality or unspecified battery in transmitter.	8b. Check battery. Use only batteries specified in the instructions (does not apply to transmitters with non-replaceable batteries).
	8c. Transmitter malfunctioning.	8c. Replace faulty transmitter.
9. Local bell and keypad sound continuously after arming.	9. Exit or interior zone contained a fault at end of Exit Delay (e.g., Exit door left open). <i>The "Exit Alarm" display, etc. will also result if an alarm from an exit or interior zone occurs within two minutes after the end of an exit delay. →</i>	9a. If system disarmed <i>before</i> ensuing entry time runs out, "CA" or "Canceled Alarm" will be displayed. Sounding will stop. 9b. If system <i>not</i> disarmed before entry time ends, "EA" or "Exit Alarm" will be displayed and Exit Alarm message will be sent to central station. Sounding will continue until system is disarmed or timeout occurs. Clear display by entering code + OFF a second time. Avoid fault when re-arming.

CONTROL

SYMPTOM	POSSIBLE CAUSE	REMEDY
1. "POWER" light off or "NO AC" displayed	1a. Interrupted AC power supply.	1a. Check transformer connection and power line circuit breaker.
2. Digital communicator message not being received.	2a. Control in TEST mode.	2a. Remove from TEST mode.
	2b. Telephone connection not secure.	2b. Check all connections.
	2c. Digital communicator malfunctioning	2c. Check with a different VISTA-10SE.
	2d. Telephone number in program needs prefix or access code.	2d. Program prefix or access code into the control
	2e. Telephone call to central monitoring station requires operator assistance.	2e. System cannot work in this situation.
3. Does not arm properly.	3a. READY light not on.	3a. Check for faulted zone(s) by pressing [*] ; make faulted zone(s) intact, or use Bypass arming, if desired.
4. VISTA-10SE doesn't respond to keystrokes on keypad.	4a. "CC" or "MODEM COMM" displayed.	4a. System is in communication with downloader at central station. Wait until download session is finished.
	4b. "d1" or "System Busy" displayed.	4b. System has just been powered and is in its one minute initialization. To bypass this time, press '# + 0'.
	4c. "E4" or "E8" displayed.	4c. More zones have been programmed than the zone expansion modules can handle. Delete some zones or use a higher capability RF receiver.
	4d. Keypad address setting incorrect.	4d. Keypads must be set for address 31 (non-addressable mode).

SMOKE DETECTOR

SYMPTOM	POSSIBLE CAUSE	REMEDY
1. Detector alarms, no apparent reason.	1a. Dust, dirt in sensing chamber.	1a. Clean unit's sensing chamber with vacuum cleaner per unit's instructions.
	1b. Improper location.	1b. See unit's instructions for locations to avoid. Relocate as necessary.
	1c. Unit malfunctioning.	1c. Replace detector.
2. Detector's siren sounds.	2a. Unit not receiving required power.	2a. Check for proper installation of battery. Try new battery.
	2b. Unit malfunctioning.	2b. Replace detector.

CONTACTING TECHNICAL SUPPORT

PLEASE,

Before you call Technical Support, be sure you:

- **READ THE INSTRUCTIONS!**
- **Check all wiring connections.**
- **Determine that the power supply and/or backup battery are supplying proper voltages.**
- **Verify your programming information where applicable.**
- **Note the proper model number of this product, and the version level (NXXXX number on large circuit module in center of control board) along with any documentation that came with the product.**
- **Note your ADEMCO customer number and/or company name.**

Having this information handy will make it easier for us to serve you quickly and effectively.

You may contact Technical Support via Toll-Free FAX. Please include your return FAX number. You will receive a reply within 24 hours. You may also contact Technical Support via modem to ATLLIS-BBS, Technical Support's Electronic Bulletin Board System. Replies are posted within 24 hours.

East Coast Technical Support: 1-800-645-7492 (8 a.m.-6 p.m. E.S.T.)

West Coast Technical Support: 1-800-458-9469 (8 a.m.-5 p.m. P.S.T.)

Technical Support FAX Number: 1-800-447-5086

ATLLIS-BBS Electronic Bulletin Board System: 1-516-496-3980
(1200 - 9600 Baud, 8 Data Bits, 1 Start/Stop Bit, No Parity)

ATLLIS FAX - Automated Fax Retrieval System: 1-800-573-0153
1-516-921-6704/Ext. 1667

ADEMCO World Wide Web Page: [HTTP://: WWW.ADEMCO.COM](http://WWW.ADEMCO.COM)

INTERNET E-Mail Address: Ademco_Tech_SPRT@Ademco-165.Ademco.com

Section 18. SPECIFICATIONS & ACCESSORIES

Specifications

VISTA-10SE SECURITY CONTROL

- 1. Physical:** 12-1/2" W x 14-1/2" H x 3" D (318mm x 368mm x 76mm)
- 2. Electrical:**
 - VOLTAGE INPUT: 16.5VAC from plug-in 25VA transformer, Ademco No. 1321/TF2 (in U.S.A.)
 - RECHARGEABLE BACK-UP BATTERY: 12VDC, 4AH (Gel type). Charging Voltage: 13.8VDC.
 - ALARM SOUNDER: 12V, 2.0 Amp output can drive 12V BELLS or can drive one or two 702 (**series** connected) self-contained 20-watt sirens. Do **not** connect two 702s in parallel.
 - AUXILIARY POWER OUTPUT: 12VDC, 500mA max. Interrupts for 4-wire smoke detector reset.
 - Note:** For UL installations, Alarm Sounder plus Auxiliary Power currents should not exceed 600mA total.
 - STANDBY TIME: (see Table in the FINAL POWER UP section)
 - FUSE: Battery (3A) No. 90-12.

3. Communication :

FORMATS SUPPORTED:

Ademco Express,

10 characters/sec, DTMF (Touch-Tone) Data Tones, 1400/2300Hz ACK, 1400Hz KISSOFF.

Ademco Contact ID Reporting,

10 characters/sec., DTMF (Touch-Tone) Data Tones, 1400/2300Hz ACK, 1400Hz KISSOFF.

Ademco Low Speed, 10 pulses/sec, 1900Hz Data Tone, 1400Hz ACK/KISSOFF.

Radionics/SESCOA, 20 pulses/sec, 1800Hz Data Tone, 2300Hz ACK/KISSOFF. Can report 0-9, B-F.

Line Seize: Double Pole.

Ringer Equivalence: 0.7B.

FCC Registration No.: AC 398U-68192-AL-E.

4. Maximum Zone Resistance: Zones 1-6 = 300 ohms excluding EOLR.

5. Zone Response: Zones 1-6: 300-500 msec

Zone 3 can be programmed for N.C. sensor fast (10 msec max.) response to an open

4127 REMOTE KEYPAD

- 1. Physical:** 5-5/8" W x 4-11/16" H x 7/8" D (143mm x 119mm x 22mm).
- 2. Electrical:** Voltage Input: 12VDC, Current Drain: 20mA.
- 3. Interface Wiring:** To control panel's keypad connection points.
 - RED: 12VDC input (+) aux power.
 - GREEN: Data Out to Control.
 - YELLOW: Data In from Control.
 - BLACK: Ground.

4137AD & 5137AD REMOTE KEYPADS

- 1. Physical:** 8-2/5" W x 4-3/4" H x 1-1/10" D (213mm x 121mm x 28mm).
- 2. Electrical:** Voltage Input: 12VDC.
Current Drain: 60mA (4137AD).
90mA(5137AD).
- 3. Interface Wiring:** Same as 4127

6127 REMOTE KEYPAD	<p>1. Physical: 5-3/4" W x 4-3/4" H x 1" D (146mm x 121mm x 26mm).</p> <p>2. Electrical: Voltage Input: 12VDC; Current Drain: 20mA.</p> <p>3. Interface Wiring: Same as 4127.</p>
6128 REMOTE KEYPAD	<p>1. Physical: 5-3/4" W x 4-3/4" H x 1" D (146mm x 121mm x 26mm).</p> <p>2. Electrical: Voltage Input: 12VDC; Current Drain: 30mA.</p> <p>3. Interface Wiring: Same as 4127.</p>
6137 REMOTE KEYPAD	<p>1. Physical: 6-1/4" W x 4-3/4" H x 1" D (159mm x 121mm x 26mm).</p> <p>2. Electrical: Voltage Input: 12VDC; Current Drain: 85mA.</p> <p>3. Interface Wiring: Same as 4127.</p>
6138 & 6139 REMOTE KEYPADS	<p>1. Physical: 6-1/4" W x 4-3/4" H x 1" D (159mm x 121mm x 26mm).</p> <p>2. Electrical: Voltage Input: 12VDC; Current Drain: 100mA.</p> <p>3. Interface Wiring: Same as 4127.</p>
4281L, 4281M, 4281H RF RECEIVERS (5700 System) and 5881L, 5881M, 5881H RF RECEIVERS (5800 System)	<p>1. Physical: 7-3/8" (188mm) W x 4-3/8" (112mm) H x 1-7/16" (37mm) D. <i>Note:</i> 10-7/8" (277mm) H with antenna.</p> <p>2. Electrical: Voltage Input: 12VDC; Current Drain: 35mA.</p> <p>3. Interface Wiring: Same as 4127.</p> <p>4. Range: 200ft (60m) nominal indoors from wireless transmitters (the actual range to be determined with system in TEST mode).</p> <p>5. Zones: (With the <i>Ademco VISTA-10SE</i>) 4281L (4281CN-L*): accepts up to 4 transmitters. 4281M/4281H (4281CN-H*): accepts up to 8 transmitters. 5881L (5882L*): accepts up to 8 transmitters. 5881M/5881H (5882H*): accepts up to 16 transmitters.</p> <p style="text-align: center;">* Used in Canada</p>
5800TM TRANSMITTER MODULE used with 5827BD Wireless 2-Way Keypad	<p>1. Physical: 2-1/4" W x 4-1/8" H x 7/8" D (57mm x 105mm x 22mm).</p> <p>2. Electrical: Voltage Input: 12VDC; Current Drain: 20mA.</p> <p>3. Interface Wiring: Same as 4127.</p>
4204 RELAY MODULE	<p>1. Physical: 6-1/2" W x 4-1/4" H x 1-1/4" D (169mm x 108mm x 32mm).</p> <p>2. Electrical: Voltage Input: 12VDC; Current Drain: 15mA (Relays off). 180mA (Relays on).</p> <p>3. Interface Wiring: Same as 4127.</p> <p>4. Four Output Relays: SPDT Contacts. Rating: 2A max at 28VDC/AC.</p>
4285 PHONE MODULE	<p>1. Physical: 6-1/2" W x 4-1/4" H x 1-1/4" D (169mm x 108mm x 32mm).</p> <p>2. Electrical: Voltage Input: 12VDC; Current Drain: 160mA.</p> <p>3. Device Address: Permanently set to address 4.</p> <p>4. Interface Wiring: See 4285 <i>PHONE MODULE</i> section.</p> <p>5. Telephone Line Connections: See 4285 <i>PHONE MODULE</i> section.</p>
7720PLUS/7820	<p>1. Physical: 8-1/2" W x 9-1/2" H x 1-3/4" D (216mm x 242mm x 45mm).</p> <p>2. Electrical: Voltage Input: 12VDC; Current Drain: 150mA.</p> <p>3. Device Address: Set to address 3.</p> <p>4. Interface Wiring: Same as 4127 above.</p>

Accessories (Compatible Devices)

No. 1321	16.5VAC, 25VA Plug-In Transformer (in U.S.A.)
No. 1321CN	16.5VAC, 25VA Plug-In Transformer (in Canada)

Sounders

Ademco AB-12M 10” Motorized Bell & Box	Motor bell & box. UL Grade A. 100mA current draw.
Ademco 1011BE12M 10” Motorized Bell & Box	Motor bell & box. UL Listed. 100mA current draw.
Ademco 702 Outdoor Siren	Self-contained 6–12 volt siren (driver built-in) and weatherproof for outdoor use. Can be wired for either a steady or warble sound. 117dB @ 10 feet. 1500mA current draw.
Ademco 719 2-Channel Siren	Self-contained 6–12-volt siren (driver built in). Steady or warble sound. 109dB @ 10 feet. 550mA current draw.
Ademco 747 Indoor Siren	Self-contained 6–15 volt siren (driver built-in) for indoor wall mount. 747F available for flush mounting. 105dB @ 10 feet. 400mA current draw.
Ademco 747UL Indoor Siren	Self-contained 6–15 volt siren (driver built-in) for indoor wall mount. UL Listed. 85dB @ 10 feet. 320mA current draw.
Ademco 744 Siren Driver	6 jumper-selected sound outputs. Rated at 119dB with use of an 8-ohm 30 watt speaker. 1.3 amps current draw.
Ademco 745X3* Voice Siren Driver	12 volt voice siren driver with English, Spanish and French voice messages. Separate messages for Fire and Burglary. Use with 8-ohm speaker. UL Listed. 1100mA current draw.
Ademco 705–820, 5-inch Round Speaker	20-watt, 8-ohm indoor or outdoor speaker. Requires a driver.
Ademco 713 Speaker	40-watt, 8-ohm, indoor/outdoor speaker. Requires a driver.
System Sensor PA400B (beige)/PA400R (red) Indoor Piezo Sounder	Indoor piezo sounder (red or beige), rated at 90 dB @ 10 feet.

* Requires special power wiring connections.

Compatible 4-Wire Smoke/Combustion Detectors

<i>System Sensor</i>	
1412	4-wire ionization products of combustion detector.
2412	4-wire photoelectric smoke detector.
2412TH	4-wire photoelectric smoke detector w/135° F (57° C) heat detector.
A77–716B	EOL relay module (supervisory module for wired 4-wire fire zone).
2112/24T	Low-profile 4-wire photoelectric smoke detector w/135° F (57° C) heat detector.

REGULATORY AGENCY STATEMENTS

FEDERAL COMMUNICATIONS COMMISSION (FCC) Part 15 STATEMENT

This equipment has been tested to FCC requirements and has been found acceptable for use. The FCC requires the following statement for your information:

This equipment generates and uses radio frequency energy and if not installed and used properly, that is, in strict accordance with the manufacturer's instructions, may cause interference to radio and television reception. It has been type tested and found to comply with the limits for a Class B computing device in accordance with the specifications in Part 15 of FCC Rules, which are designed to provide reasonable protection against such interference in a residential installation. However, there is no guarantee that interference will not occur in a particular installation. If this equipment does cause interference to radio or television reception, which can be determined by turning the equipment off and on, the user is encouraged to try to correct the interference by one or more of the following measures:

- If using an indoor antenna, have a quality outdoor antenna installed.
- Reorient the receiving antenna until interference is reduced or eliminated.
- Move the radio or television receiver away from the receiver/control.
- Move the antenna leads away from any wire runs to the receiver/control.
- Plug the receiver/control into a different outlet so that it and the radio or television receiver are on different branch circuits.

If necessary, the user should consult the dealer or an experienced radio/television technician for additional suggestions. The user or installer may find the following booklet prepared by the Federal Communications Commission helpful: "Interference Handbook"

This booklet is available from the U.S. Government Printing Office, Washington, DC 20402.

The user shall not make any changes or modifications to the equipment unless authorized by the Installation Instructions or User's Manual. Unauthorized changes or modifications could void the user's authority to operate the equipment.

FEDERAL COMMUNICATIONS COMMISSION (FCC) Part 68 STATEMENT

This equipment complies with Part 68 of the FCC rules. On the front cover of this equipment is a label that contains, among other information, the FCC registration number and ringer equivalence number (REN) for this equipment. If requested, this information must be provided to the telephone company.

This equipment uses the following jacks: An RJ31X is used to connect this equipment to the telephone network.

The REN is used to determine the quantity of devices which may be connected to the telephone line. Excessive RENs on the telephone line may result in the devices not ringing in response to an incoming call. In most, but not all areas, the sum of the RENs should not exceed five (5.0). To be certain of the number of devices that may be connected to the line, as determined by the total RENs, contact the telephone company to determine the maximum REN for the calling area.

If this equipment causes harm to the telephone network, the telephone company will notify you in advance that temporary discontinuance of service may be required. If advance notice is not practical, the telephone company will notify the customer as soon as possible. Also, you will be advised of your right to file a complaint with the FCC if you believe necessary.

The telephone company may make changes in its facilities, equipment, operations, or procedures that could affect the operation of the equipment. If this happens, the telephone company will provide advance notice in order for you to make the necessary modifications in order to maintain uninterrupted service.

If trouble is experienced with this equipment, please contact the manufacturer for repair and warranty information. If the trouble is causing harm to the telephone network, the telephone company may request you remove the equipment from the network until the problem is resolved.

There are no user serviceable components in this product, and all necessary repairs must be made by the manufacturer. Other repair methods may invalidate the FCC registration on this product.

This equipment cannot be used on telephone company-provided coin service. Connection to Party Line Service is subject to state tariffs.

This equipment is hearing-aid compatible.

When programming or making test calls to an emergency number, briefly explain to the dispatcher the reason for the call. Perform such activities in the off-peak hours; such as early morning or late evening.

UL NOTICES

1. This is a "Grade A" residential system.
2. The 4285 Phone module and 7720PLUS or 7820 Long Range Radios have not been UL tested and cannot, therefore, be used in a UL installation.
3. The Entry Delay (field *38) cannot be greater than 45 seconds for UL installations.
4. The maximum number of reports per armed period (field *92) must be unlimited (set to 1) for UL installations.
5. Periodic testing (field *49) must be at least every 24 hours (set to 1) for UL installations.
6. Alarm Sounder plus Auxiliary Power currents must not exceed 600mA total for UL installations.
7. Downloading is not permissible for UL installations.

CALIFORNIA STATE FIRE MARSHAL (CSFM) AND UL RESIDENTIAL FIRE 24 HOUR BATTERY BACK-UP REQUIREMENTS

The California State Fire Marshal and UL have regulations which require that all residential fire alarm control panels must be provided with a back-up battery which has sufficient capacity to operate the panel and its attached peripheral devices for 24 hours in the intended standby condition, followed by at least 4 minutes in the intended fire alarm signaling condition.

This control panel can meet these requirements without using a supplementary power supply, provided that the panel's auxiliary power and bell output currents are limited as indicated below.

OUTPUT LIMITATIONS TO MEET CSFM 24 HOUR BATTERY BACK-UP REQUIREMENTS AND UL LISTED RESIDENTIAL FIRE INSTALLATIONS			
OUTPUT CURRENT LIMITATIONS		BATTERY INFORMATION	
OUTPUT CURRENT TOTAL	MAXIMUM AUXILIARY CURRENT	BATTERY CAPACITY TO USE (Amp/Hrs)	RECOMMENDED BATTERY (Yuasa Model No.)
700mA maximum total of auxiliary power plus bell output currents.	45mA	4AH	NP4-12
	160mA	7AH	NP7-12
	200mA	8AH	NP4-12 (two) ‡
	425mA	14AH	NP7-12 (two) ‡
	500mA	17.2AH	NPG18-12

‡**Note:** Use two batteries, connected in parallel. Obtain an Ademco Battery Harness kit. A dual battery harness is provided with the kit. Both batteries will fit inside the panel's cabinet.

CANADIAN DEPARTMENT OF COMMUNICATIONS (DOC) STATEMENT

NOTICE

The Canadian Department of Communications label identifies certified equipment. This certification means that the equipment meets certain telecommunications network protective, operational and safety requirements. The Department does not guarantee the equipment will operate to the user's satisfaction.

Before installing this equipment, users should ensure that it is permissible to be connected to the facilities of the local telecommunications company. The equipment must also be installed using an acceptable method of connection. In some cases, the company's inside wiring associated with a single line individual service may be extended by means of certified connector assembly (telephone extension cord). The customer should be aware that compliance with the above conditions may not prevent degradation of service in some situations.

Repairs to certified equipment should be made by an authorized Canadian maintenance facility designated by the supplier. Any repairs or alterations made by the user to this equipment, or equipment malfunctions, may give the telecommunications company cause to request the user to disconnect the equipment.

Users should ensure for their own protection that the electrical ground connections of the power utility, telephone lines and internal metallic water pipe system, if present, are connected together. This precaution may be particularly important in rural areas.

Caution: User should not attempt to make such connections themselves, but should contact the appropriate electric inspection authority, or electrician, as appropriate.

The Load Number (LN) assigned to each terminal device denotes the percentage of the total load to be connected to a telephone loop which is used by the device, to prevent overloading. The termination on a loop may consist of any combination of devices subject only to the requirement that the total of the Load Numbers of all the devices does not exceed 100.

AVIS

L'étiquette du ministère des Communications du Canada identifie le matériel homologué. Cette étiquette certifie que le matériel est conforme à certaines normes de protection, d'exploitation et de sécurité des réseaux de télécommunications. Le ministère n'assure toutefois pas que le matériel fonctionnera à la satisfaction de l'utilisateur.

Avant d'installer ce matériel, l'utilisateur doit s'assurer qu'il est permis de le raccorder aux installations de l'entreprise locale de télécommunications. Le matériel doit également être installé en suivant une méthode acceptée de raccordement. Dans certains cas, les fils intérieurs de l'entreprise utilisés pour un service individuel à la ligne unique peuvent être prolongés au moyen d'un dispositif homologué de raccordement (cordon prolongateur téléphonique interne). L'abonné ne doit pas oublier qu'il est possible que la conformité aux conditions énoncées ci-dessus n'empêche pas la dégradation du service dans certaines situations. Actuellement, les entreprises de télécommunications ne permettent pas que l'on raccorde leur matériel aux prises d'abonnés, sauf dans les cas précis prévus par les tarifs particuliers de ces entreprises.

Les réparations du matériel homologué doivent être effectuées par un centre d'entretien canadien autorisé désigné par le fournisseur. La compagnie de télécommunications peut demander à l'utilisateur de débrancher un appareil à la suite de réparations ou de modifications effectuées par l'utilisateur ou à cause de mauvais fonctionnement.

Pour sa propre protection, l'utilisateur doit s'assurer que tous les fils de mise en terre de la source d'énergie électrique, des lignes téléphoniques de réseau de conduites d'eau, s'il y en a, soient raccordés ensemble. Cette précaution est particulièrement importante dans les régions rurales.

Avertissement: L'utilisateur ne doit pas tenter de faire ces raccordements lui-même; il doit avoir recours à un service d'inspection des installations électriques, ou à un électricien, selon le cas.

L'indice de charge (IC) assigné à chaque dispositif terminal pour éviter toute surcharge indique le pourcentage de la charge totale qui peut être raccordé à un circuit téléphonique bouclé utilisé par ce dispositif. La terminaison du circuit bouclé peut être constituée de n'importe quelle combinaison de dispositifs, pourvu que la somme des indices de charge de l'ensemble des dispositifs ne dépasse pas 100.

WARNING! THE LIMITATIONS OF THIS ALARM SYSTEM

While this System is an advanced design security system, it does not offer guaranteed protection against burglary, fire or other emergency. Any alarm system, whether commercial or residential, is subject to compromise or failure to warn for a variety of reasons. For example:

- Intrusion detectors (e.g., passive infrared detectors), smoke detectors, and many other sensing devices will not work without power. Battery-operated devices will not work without batteries, with dead batteries, or if the batteries are not put in properly. Devices powered solely by AC will not work if their AC power supply is cut off for any reason, however briefly.
- Signals sent by wireless transmitters may be blocked or reflected by metal before they reach the alarm receiver. Even if the signal path has been recently checked during a weekly test, blockage can occur if a metal object is moved into the path.
- A user may not be able to reach a panic or emergency button quickly enough.
- While smoke detectors have played a key role in reducing residential fire deaths in the United States, they may not activate or provide early warning for a variety of reasons in as many as 35% of all fires, according to data published by the Federal Emergency Management Agency. Some of the reasons smoke detectors used in conjunction with this System may not work are as follows. Smoke detectors may have been improperly installed and positioned. Smoke detectors may not sense fires that start where smoke cannot reach the detectors, such as in chimneys, in walls, or roofs, or on the other side of closed doors. Smoke detectors also may not sense a fire on another level of a residence or building. A second floor detector, for example, may not sense a first floor or basement fire. Finally, smoke detectors have sensing limitations. No smoke detector can sense every kind of fire every time. In general, detectors may not always warn about fires caused by carelessness and safety hazards like smoking in bed, violent explosions, escaping gas, improper storage of flammable materials, overloaded electrical circuits, children playing with matches, or arson. Depending on the nature of the fire and/or location of the smoke detectors, the detector, even if it operates as anticipated, may not provide sufficient warning to allow all occupants to escape in time to prevent injury or death.
- Passive Infrared Motion Detectors can only detect intrusion within the designed ranges as diagrammed in their installation manual. Passive Infrared Detectors do not provide volumetric area protection. They do create multiple beams of protection, and intrusion can only be detected in unobstructed areas covered by those beams. They cannot detect motion or intrusion that takes place behind walls, ceilings, floors, closed doors, glass partitions, glass doors, or windows. Mechanical tampering, masking, painting or spraying of any material on the mirrors, windows or any part of the optical system can reduce their detection ability. Passive Infrared Detectors sense changes in temperature; however, as the ambient temperature of the protected area approaches the temperature range of 90° to 105°F (32° to 40°C), the detection performance can decrease.
- Alarm warning devices such as sirens, bells or horns may not alert people or wake up sleepers if they are located on the other side of closed or partly open doors. If warning devices are located on a different level of the residence from the bedrooms, then they are less likely to waken or alert people inside the bedrooms. Even persons who are awake may not hear the warning if the alarm is muffled by noise from a stereo, radio, air conditioner or other appliance, or by passing traffic. Finally, alarm warning devices, however loud, may not warn hearing-impaired people.
- Telephone lines needed to transmit alarm signals from a premises to a central monitoring station may be out of service or temporarily out of service. Telephone lines are also subject to compromise by sophisticated intruders.
- Even if the system responds to the emergency as intended, however, occupants may have insufficient time to protect themselves from the emergency situation. In the case of a monitored alarm system, authorities may not respond appropriately.
- This equipment, like other electrical devices, is subject to component failure. Even though this equipment is designed to last as long as 20 years, the electronic components could fail at any time.

The most common cause of an alarm system not functioning when an intrusion or fire occurs is inadequate maintenance. This alarm system should be tested weekly to make sure all sensors and transmitters are working properly. The security keypad (and remote keypad) should be tested as well.

Wireless transmitters (used in some systems) are designed to provide long battery life under normal operating conditions. Longevity of batteries may be as much as 4 to 7 years, depending on the environment, usage, and the specific wireless device being used. External factors such as humidity, high or low temperatures, as well as large swings in temperature, may all reduce the actual battery life in a given installation. This wireless system, however, can identify a true low battery situation, thus allowing time to arrange a change of battery to maintain protection for that given point within the system.

Installing an alarm system may make the owner eligible for a lower insurance rate, but an alarm system is not a substitute for insurance. Homeowners, property owners and renters should continue to act prudently in protecting themselves and continue to insure their lives and property.

We continue to develop new and improved protection devices. Users of alarm systems owe it to themselves and their loved ones to learn about these developments.

Figure 15. VISTA-10SE SUMMARY OF CONNECTIONS DIAGRAM

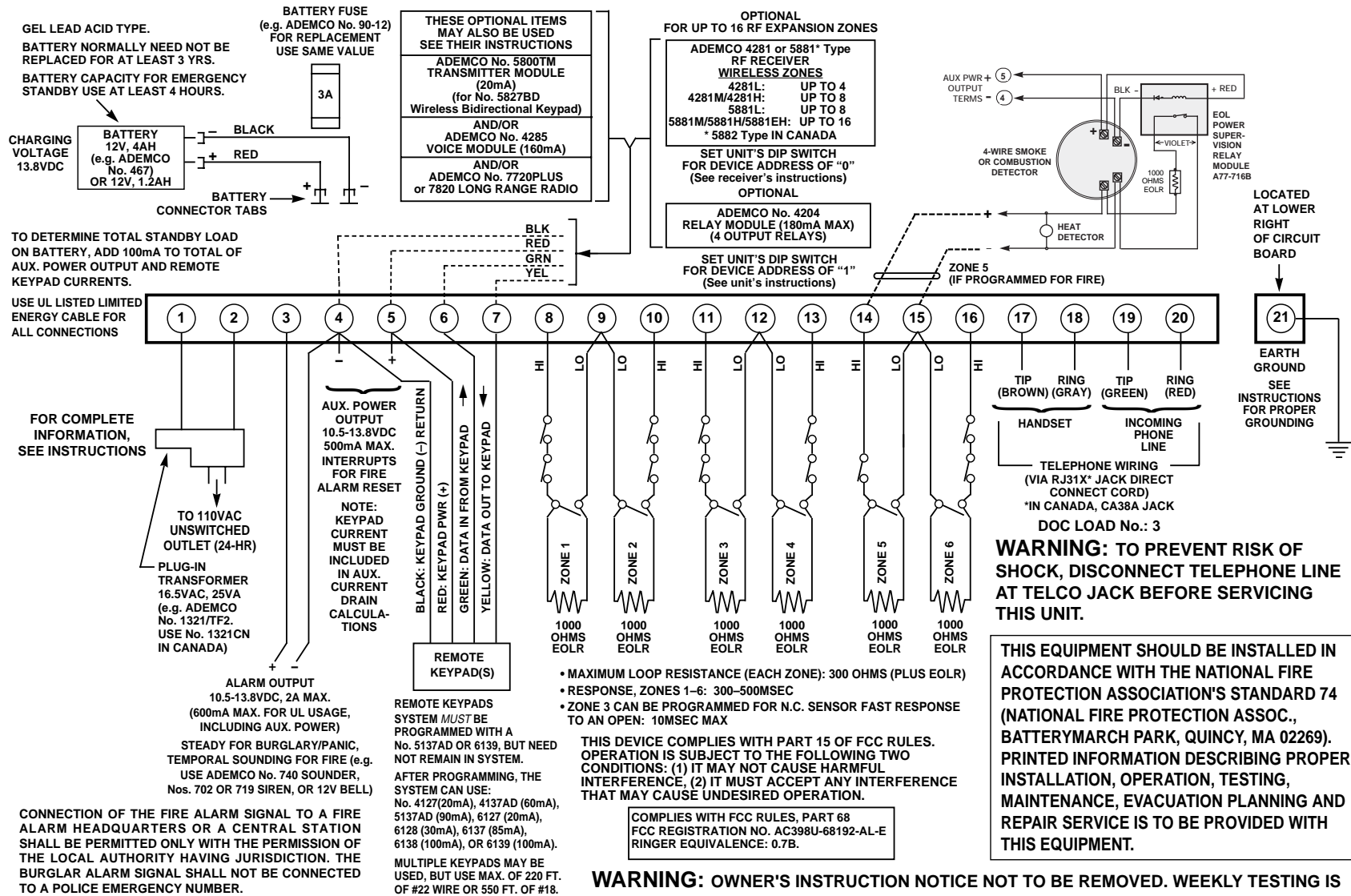

ADEMCO LIMITED WARRANTY

Alarm Device Manufacturing Company, a Division of Pittway Corporation, and its divisions, subsidiaries and affiliates ("Seller"), 165 Eileen Way, Syosset, New York 11791, warrants its products to be in conformance with its own plans and specifications and to be free from defects in materials and workmanship under normal use and service for 24 months from the date stamp control on the product or, for products not having an Ademco date stamp, for 12 months from date of original purchase unless the installation instructions or catalog sets forth a shorter period, in which case the shorter period shall apply. Seller's obligation shall be limited to repairing or replacing, at its option, free of charge for materials or labor, any product which is proved not in compliance with Seller's specifications or proves defective in materials or workmanship under normal use and service. Seller shall have no obligation under this Limited Warranty or otherwise if the product is altered or improperly repaired or serviced by anyone other than Ademco factory service. For warranty service, return product transportation prepaid, to Ademco Factory Service, 165 Eileen Way, Syosset, New York 11791.

THERE ARE NO WARRANTIES, EXPRESS OR IMPLIED, OF MERCHANTABILITY, OR FITNESS FOR A PARTICULAR PURPOSE OR OTHERWISE, WHICH EXTEND BEYOND THE DESCRIPTION ON THE FACE HEREOF. IN NO CASE SHALL SELLER BE LIABLE TO ANYONE FOR ANY CONSEQUENTIAL OR INCIDENTAL DAMAGES FOR BREACH OF THIS OR ANY OTHER WARRANTY, EXPRESS OR IMPLIED, OR UPON ANY OTHER BASIS OF LIABILITY WHATSOEVER, EVEN IF THE LOSS OR DAMAGE IS CAUSED BY THE SELLER'S OWN NEGLIGENCE OR FAULT.

Seller does not represent that the products it sells may not be compromised or circumvented; that the products will prevent any personal injury or property loss by burglary, robbery, fire or otherwise; or that the products will in all cases provide adequate warning or protection. Customer understands that a properly installed and maintained alarm may only reduce the risk of a burglary, robbery, fire or other events occurring without providing an alarm, but it is not insurance or a guarantee that such will not occur or that there will be no personal injury or property loss as a result. CONSEQUENTLY, SELLER SHALL HAVE NO LIABILITY FOR ANY PERSONAL INJURY, PROPERTY DAMAGE OR OTHER LOSS BASED ON A CLAIM THE PRODUCT FAILED TO GIVE WARNING. HOWEVER, IF SELLER IS HELD LIABLE, WHETHER DIRECTLY OR INDIRECTLY, FOR ANY LOSS OR DAMAGE ARISING UNDER THIS LIMITED WARRANTY OR OTHERWISE, REGARDLESS OF CAUSE OR ORIGIN, SELLER'S MAXIMUM LIABILITY SHALL NOT IN ANY CASE EXCEED THE PURCHASE PRICE OF THE PRODUCT, WHICH SHALL BE THE COMPLETE AND EXCLUSIVE REMEDY AGAINST SELLER. This warranty replaces any previous warranties and is the only warranty made by Seller on this product. No increase or alteration, written or verbal, of the obligations of this Limited Warranty is authorized.

ADEMCO
GROUP

165 Eileen Way, Syosset, New York 11791

Copyright © 1997 PITTWAY CORPORATION